

Hertsmere Local Plan

Parking Standards



Supplementary Planning Document

July 2014

Contents

1	<i>Introduction</i>	1
2	<i>Residential Parking Standards</i>	4
3	<i>Non-Residential parking standards</i>	9
4	<i>Design and Layout of Parking Spaces</i>	15
5	<i>Travel Plans</i>	21
6	<i>Section 106 and CIL Contributions for Highways and Transport</i>	22
7	<i>Transport Assessments</i>	23
8	<i>Contact Details</i>	24
	<i>Appendix 1: Policy Background</i>	25
	<i>Appendix 2: Worked Examples</i>	28
	<i>Appendix 3: Travel Plan Checklist</i>	30
	<i>Appendix 4: Accessibility Zones Methodology</i>	32
	<i>Appendix 5: Residential Accessibility Zones within Hertsmere</i>	34
	<i>Appendix 6: Non-Residential Accessibility Zones within Hertsmere</i>	43

1 Introduction

What does the Supplementary Planning Document (SPD) cover?

- 1.1 This updated SPD sets out the Council's off-street parking standards for new developments. Applications for planning permission will be assessed against the standards contained in this document until its formal adoption.
- 1.2 Guidance is presented on the levels of car parking, cycle parking, motorcycle parking, electric car parking and disabled parking that should be provided at new developments. Information and advice on design and layout is also given.
- 1.3 The SPD defines Accessibility Zones in the main towns. These are areas within the Borough where less stringent car parking standards can be applied in appropriate circumstances. This document explains the criteria that will be considered in determining the level of reduction to be applied.
- 1.4 The circumstances in which developers will be required to submit a Travel Plan alongside a planning application are set out. Advice is also provided on the content that should be included in a Travel Plan.
- 1.5 The SPD provides information on Section 106 legal agreements for highways and transport matters and also sets out guidelines on when the Council will require Transport Assessments to be submitted alongside applications for planning permission.

Why is an updated SPD required?

- 1.6 This SPD updates the previous Parking Standards SPD, which were published in 2010. The National Planning Policy Framework (NPPF) states that policies in development plans can set local levels of parking for residential and non-residential development. Previously, national planning policy had sought maximum parking standards. The following criteria contained in Paragraph 39 of the NPPF should be noted:
 - The accessibility of the development;
 - The type, mix and use of the development;
 - The availability of and opportunities for public transport;
 - Local car ownership levels; and
 - An overall need to reduce the use of high emission vehicles.

The NPPF also states that local authorities should seek opportunities to improve the quality of parking in town centres, taking account of requirements for motorcycles.

- 1.7 Hertsmere's existing Local Plan 2003 policies and the Core Strategy 2013 do not set out specific standards for the provision of cycle parking at new development. Previous Supplementary Planning Guidance produced by Hertfordshire County Council did contain cycle parking standards. However, the Secretary of State's decision to delete the associated Structure Plan policy means that this advice can no longer be applied. It is therefore considered appropriate to develop and articulate local standards.

What are the SPD objectives?

- 1.8 The Core Strategy adopted in 2013 contains 15 objectives for Hertsmere's new Local Plan. Of these objectives, the following are identified as being relevant to the Parking Standards SPD:
 - To provide the spatial policies necessary to deliver the land use requirements of the Hertsmere Together Community Strategy (Objective 1).

- To raise levels of access by seeking development in locations not dependent on access by car and by requiring the provision of physically accessible transport interchanges and other buildings (Objective 8).
- To promote safe and healthy communities, respecting the diverse needs of the whole Borough (Objective 9).
- To secure efficient land use through well-designed development reflecting the size, pattern and character of settlements in Hertsmere (Objective 14).

1.9 Two additional objectives, specific to this updated SPD have also been identified:

- To reduce the carbon emissions of new developments by promoting and providing for alternatives to the private car through the use of Travel Plans and other measures.
- To assist the delivery of objectives identified in the Local Transport Plan for Hertfordshire 2011-2031 and associated programmes and local area plans.

To which Plan policies does the SPD relate?

- 1.10 This SPD has been prepared whilst the Council is in the process of replacing the Local Plan with a series of Development Plan Documents (DPDs) that will make up the new Local Plan. The Local Plan Core Strategy was adopted in January 2013. Policy CS25 replaced Policy M13 of the Local Plan 2003, with a principles on accessibility and parking, stating that proposals for new development will, among a number of criteria, be assessed against the requirements set out in this SPD. The SPD should be read in conjunction with policies in both the saved Local Plan and the emerging
- 1.11 Other relevant policies contained in the Core Strategy 2013 include CS24, which covers the location of major development and states that the Parking Standards SPD will contain guidance on Travel Plans, and CS26 which states that new developments should promote alternatives to the private car having regard to the measures set out in this document.
- 1.12 Local Plan Policy D20 (Supplementary Guidance) states that the Council will maintain a series of supplementary guidance leaflets to develop and explain plan policies, which will be added to/amended from time to time, and will constitute a material consideration in the determination of applications.
- 1.13 Under the provisions of the Planning and Compulsory Purchase Act 2004, all policies in the Local Plan were automatically 'saved' for a period of three years from 27th September 2004, unless expressly replaced by a new policy. The Secretary of State recently released a direction saving the majority of policies in the Hertsmere Local Plan, including policy D20, beyond 27th September 2007. Policy M13 was also saved at this time, and has now been superseded by Policy CS25 of the Core Strategy.

How have the policies in the SPD been formulated?

- 1.14 The NPPF states that 'Local plans should set out the opportunities for development and clear policies on what will or will not be permitted and where'. Such documents must also be founded on a credible evidence base and have due regard to the authority's Community Strategy and any other relevant plans, policies and strategies.
- 1.15 In reviewing the original SPD, regard has been given to the wider policy context, which has changed over the last 5 years and the documents that have helped to guide the

development of the objectives set out above and the detailed standards set out in this SPD. Details of the relevant policies and evidence base are updated in Appendix 1.

Sustainability Appraisal

- 1.16 The measures contained in the original SPD were subjected to Sustainability Appraisal in accordance with the requirements of Part 19(5) of the Planning and Compulsory Purchase Act 2004. There is no longer a requirement to prepare a Sustainability Appraisal for SPDs and so no additional Sustainability Appraisal work has been undertaken for this particular document. However, the Council's Local Plan Core Strategy, adopted in 2013 and containing policies to which this SPD is linked, was subject to a full Sustainability Appraisal.

When should this guidance be applied?

- 1.17 The residential parking standards contained in Section 2 will apply to all developments involving the provision of 1 or more residential units (gross).
- 1.18 Applications for extensions and alterations to existing dwellings should ensure that a suitable level of parking provision is made. The standards contained in Section 2 will be used as a guide having regard to the size of the dwelling that is to be created, the impact upon highway safety and the level of provision that already exists on site.
- 1.19 The non-residential parking standards contained in Section 3 will apply to all developments that result in the creation of non-residential floorspace. This includes the extension and alteration of existing non-residential premises and all changes of use.
- 1.20 Where mixed-use, residential and commercial developments are proposed, the parking requirements for each element should be calculated individually using the standards contained in Sections 2 and 3. Where appropriate, the Council will consider the shared use of parking between residential and commercial elements where it can be demonstrated that the relevant standards are met.
- 1.21 The design and layout guidance contained in Section 4 will apply to all development (including extensions and alterations to existing dwellings) where new parking is to be provided or existing parking provision is to be altered.
- 1.22 Proposals for larger schemes, including all Major Developments (as defined in statute) will be assessed against the criteria and thresholds set out in Section 5 (Travel Plans), Section 6 (Section 106 contributions) and Section 7 (Transport Assessments). Other proposals may need to meet some of the requirements in these sections.

2 Residential Parking Standards

Figure 1: Residential Parking Standards

C3		
General Needs Housing* (including flats and bungalows)		
Studio / bedsit	1.5 per unit	1 secure / long term space per unit <i>plus</i> 1 short term space per 5 units where communal parking is to be provided
1 bedroom	1.5 per unit	
2 bedroom	2 per unit	
3 bedroom	2 per unit	
4 bedroom	3 per unit	
5 bedroom	4 per unit	
6 bedroom	5 per unit (and one additional space per bedroom thereafter)	
Additional parking requirements		
Houses with additional habitable rooms on upper floors/roofspace	1 per additional habitable room ***	
Flats or Bungalows with a total of 6 or more habitable rooms and bedrooms	1 per additional habitable room ***	
Houses with 5 or more habitable rooms on the ground or lower ground floor	1 per additional habitable room ***	
Elderly Persons Housing**		
Category I – Retirement dwellings, no warden control, 1 bedroom	1.5 per unit	1 short term space per 3 units plus 1 long term space per 5 units
Category I – Retirement dwellings, no warden control, 2 bedroom	2 per unit	
Category II – Warden Control, sheltered dwellings, 1 or 2 bedroom	1 per unit	
Category I or Category II – More than 2 bedrooms	To be determined on a case by case basis	

*Standards applicable to all dwelling types unless specifically stated

** Category III Elderly Persons Housing is classified as a C2 use under the Use Classes order. Parking requirements for Category III housing is set out in Section 5, Non-Residential Parking Standards. Extra Care housing will be considered against the C3 parking requirements unless it can be demonstrated that it is specifically for frail older persons.

*** All rooms over 8 square metres which are not kitchens, utility rooms, bathrooms, WCs or circulation space are considered to be a habitable room. Large habitable rooms or open plan areas, typically over 25 sq metres and capable of subdivision will be treated as two habitable rooms. Parking requirements for additional habitable rooms on upper floors within townhouses or dwellings with reversed layouts will be considered on their individual merits but will not typically be sought unless there are three or more additional habitable rooms within the entire property.

- 2.1 Figure 1 sets out the Council's residential parking standards. The car parking standards show the required levels of provision in line with advice in the NPPF. The cycle parking standards represent the minimum level of provision. For dwellings that have larger numbers of habitable rooms, additional car parking spaces will be sought. This will also be applied when applications are received to convert garages into habitable rooms within

existing dwellings. One bedroom flats and bungalows with three or four other habitable rooms will be treated as two or three bedroom properties for the purposes of calculating off-street parking requirements.

- 2.2 There will be an initial presumption for the required car parking standard to be applied. Developers proposing car parking above or below these levels should provide robust evidence to support their case. Where necessary, the required level of provision should be rounded to the nearest whole number. Further guidance on the design and layout of parking provision is contained in Section 6.

Car parking for Affordable Housing

- 2.3 Vehicle ownership amongst Shared Ownership households in Hertsmere is broadly comparable to other private market households. Parking provision for Shared Ownership properties should therefore be made at the levels set out in Figure 1 and in accordance with the advice in Paragraphs 3.1 and 3.2.
- 2.4 There is little evidence that levels of vehicle ownership for general needs social rented housing are significantly lower than that for market or intermediate housing, particularly in respect of the proportion of households with one car. In mixed-tenure schemes, reduced levels of parking for Affordable Housing can exacerbate any visual differences between the market and non-market elements of a development.

Disabled car parking provision

- 2.5 Where communal parking is proposed over 20 units, 6% of the total number of spaces should be provided for exclusive disabled use plus 1 space of sufficient dimensions to be used by disabled persons for every 10 units. This should be provided over and above general parking requirements. Requirements for smaller schemes, over and above general parking requirements, are set out in the table below.

Figure 2: Disabled car parking provision

Scheme size	Exclusive disabled spaces	Spaces meeting disabled standards
5-10 units	1 space	0
11-20 units	1 space	1 space
21-30 units	6%	+1 space
31-40 units	6%	+2 Spaces

Car parking for Elderly Persons Housing

- 2.6 The definitions of Elderly Persons Housing are set out in the Housing Corporation's Scheme Development Standards:
- Category I: Self-contained accommodation for the more active elderly, which may include an element of warden and/or call support and/or additional communal facilities.
 - Category II: Self-contained accommodation for the less active elderly, which includes warden or 24 hour peripatetic cover and the full range of communal facilities.
- 2.7 100% of the parking requirement for Category I and Category II developments should be of sufficient dimensions to be used by disabled persons. Where applicable, the standards for Elderly Persons Housing should be subject to the discounts set out below.

Car parking for Motorcycles and other powered two-wheelers

- 2.8 Where communal parking is proposed, major residential applications will be required to make provision for motorcycles and other powered two-wheelers. As a guide, 5% (1 in 20) of

the required car parking provision (excluding disabled car parking spaces) should be allocated for motorcycle use.

Car parking with electric charging points

- 2.9 The NPPF states that there is an overall need to reduce the use of high-emission vehicles. Therefore the council will ensure that consideration is given to making provision for electric vehicle charging infrastructure in new developments. It is recognized that making provision for electric vehicle charging points will potentially reduce emissions and thereby contribute towards sustainable development.
- 2.10 New residential developments that consist of 50 or more new homes are expected to have provision for electric charging points. In developments of below 50 new homes, electric charging points are encouraged. New non-residential / commercial developments under 5,000 square metres are encouraged to have provision for electrical charging points. Non-residential developments of 5,000 square meters of more are expected to have provision for electric charging points.
- 2.11 Electric charging points and parking for mobility scooters should be provided in new developments in a convenient location at ground floor level where possible. This particularly applies to flatted developments and elderly persons housing where it may be difficult for occupants to charge scooters within the property itself.

Accessibility Zones

- 2.12 Residential accessibility zones have been identified in the Borough's main towns. These zones are different to those identified for non-residential developments as, in addition to the availability of journey to work public transport, accessibility to key services, including schools, the Borough's main retail centres and GP practices is also considered. Maps of the residential accessibility zones are attached to this SPD.
- 2.13 Applications for new residential development in these areas should seek to promote the use of walking, cycling and public transport. In addition, the Council will consider the provision of car parking below the required levels in accessibility zones using the guideline discount ranges set out in Figure 3. With the exception of Elderly Persons Housing, disabled car parking provision should not be subject to discounting and should always be provided at the full standard. Worked examples are provided in Appendix 2.
- 2.14 Discounted car parking levels in accessibility zones will not apply automatically and will need to be subject to justification by the applicant. The required standard will form the starting point for negotiation. The Council will take into account the criteria in paragraph 2.20 in determining whether a discount is acceptable. Worked examples are provided in Appendix 2.

Figure 3: Residential Accessibility Zone discounts

Zone	Level of Car Parking Provision (Excluding disabled parking)
2	25 – 100%
3	50 – 100%
4	75 – 100%

- 2.15 The following factors will be taken into account by the Council when considering a discount:
- The type, tenure, size and mix of housing;
 - The layout, design and form of parking provision;
 - Whether the road layout is to be adopted and / or designed to adoptable standard;
 - On-street parking conditions in the surrounding areas;
 - Access to existing public or private car parking facilities and the potential for shared parking;
 - Proximity to public transport and services;
 - The level of cycle parking provided; and
 - The provision of mitigating measures (see paragraph 3.11).
- 2.16 Developments consisting primarily of smaller flats (1- and 2-bed) with shared parking areas are most likely to qualify for a greater reduction in parking provision. Car ownership among units of this type has been shown to be lower than average. Communal parking areas will also provide greater scope for differences in car ownership between individual units to be balanced out.
- 2.17 The Council will pay particular attention to the overall housing and road layout in considering whether discounting is acceptable. Some developers are now submitting layouts which are not being designed to meet adoptable highway standards. These schemes may have narrow estate roads which may be unable to accommodate on-street parking and being private roads, would be difficult to make subject to Council controls.
- 2.18 The Council will consider schemes that propose the shared use of existing car parking facilities where this can be reasonably accommodated (e.g. the use of business car parking facilities by residential developments during evenings and weekends). Parking in excess of the stated required standard will exceptionally be permitted on town centre or edge of centre sites where genuine opportunities for shared parking exist.
- 2.19 Where new development or conversions are proposed within or close to an existing Controlled Parking Zone (CPZ), developers should take into account of the Council's Parking Management Strategy (November 2012) and the fact that there is unlikely to be any additional on-street parking capacity. In particular, the Council will expect all parking requirements to be met on site and parking permits will not normally be issued on these developments. Developers are strongly urged to make prospective purchasers of affected new dwellings aware of this and the Council will seek to attach an informative to planning permission to make applicants and other parties aware of this. The Council may also seek to use appropriate legal measures to remove the right for occupiers of new developments in existing CPZs to obtain parking permits
- 2.20 In order to qualify for the maximum discount, developments will be expected to provide cycle parking above the minimum required standard for units with more than 1 bedroom.
- 2.21 Measures to mitigate against the parking and / or transport impacts of new development may include (but are not limited to):
- On- or off-site highway works to facilitate the use of alternative modes;
 - The provision of a Travel Plan;

- Section 106 contributions or CIL towards sustainable transport measures (including Greenways routes); and
- Section 106 contributions or CIL towards the development and / or implementation and control of CPZs.

Car Free Residential Development

- 2.22 A number of existing properties, notably flats above shops in the Borough's main town centres, do not provide car-parking facilities for residents. In accessibility zones 2 and 3, there may be a limited number of cases where, subject to compliance with other relevant Local Plan policies, car-free development can be considered acceptable in principle. These may include:
- The extension, alteration or re-use of an existing building with no access to parking;
 - The reversion of a previously converted property to its original residential use, including flats above shops;
 - The provision of residential accommodation on a small (up to 5 units net) town centre site that may otherwise not come forwards for development; and
 - Where arrangements are made to share an existing car-park within the vicinity of the site which can reasonably accommodate the parking demand generated by the development.
- 2.23 In all instances, developers will be required to demonstrate why car-free development represents the best available option. Regard will be had to the criteria identified in paragraph 3.8 and the advice in paragraphs 3.9 to 3.11.

3 Non-Residential parking standards

Unless otherwise stated, floor areas are gross measured externally.

FTE = full time equivalent

s/t = short term

l/t = long term

Please note parking requirements will be rounded up or down to the nearest whole parking space requirement (e.g. a B1 development of 275sq m would be expected to provide 11 car parking spaces, rather than 10.7 spaces).

Figure 4: Non-Residential Parking Standards

Use Class / Type	Required number of car parking spaces (includes visitor spaces unless otherwise stated)	Minimum cycle parking standard
A1		
Hypermarkets Superstores Large supermarkets	1 space per 14 m ²	1 s/t space per 150 m ² 1 l/t space per 10 staff
Retail warehouses Garden centres Other retail uses	1 space per 35 m ²	
A2		
Financial and professional services (Banks, building societies etc.)	1 space per 40 m ² (Town centres) 1 space per 30 m ² (neighbourhood or local centres)	1 s/t space per 200 m ² 1 l/t space per 10 staff
A3		
Restaurants and Cafes	1 space per 5 m ² of public floorspace	1 s/t space per 100 m ² 1 l/t space per 10 staff
A4		
Drinking establishments	1 space per 5 m ² of public floorspace	1 s/t space per 100 m ² 1 l/t space per 10 staff
A5		
Hot food takeaways	1 space per 5 m ² of public floorspace	1 s/t space per 100 m ² 1 l/t space per 10 staff
B1		
Offices	1 space per 30 m ²	1 s/t space per 500 m ² 1 l/t space per 10 staff
Research and Development	1 space per 30 m ²	
Light industrial up to 250 m ² floorspace	1 space per 25 m ²	
Light industrial over 250 m ² floorspace	10 spaces plus 1 space per 35 m ²	
B2		
General industrial up to 250 m ² floorspace	1 space per 25 m ²	1 s/t space per 500 m ² 1 l/t space per 10 staff
General industrial over 250 m ² floorspace	10 spaces plus 1 space per 35 m ²	
B8		
Storage or distribution up to 250 m ² floorspace	1 space per 25 m ²	1 l/t space per 10 staff

Use Class / Type	Required number of car parking spaces (includes visitor spaces unless otherwise stated)	Minimum cycle parking standard
Storage or distribution over 250 m ² floorspace	10 spaces plus 1 space per 35 m ²	
B1 / B2 / B8		
Flexible consent	1 space per 40 m ²	1 s/t space per 500 m ² 1 l/t space per 10 staff
C1		
Hotels and motels ¹	1 space per bedroom plus 2 spaces per 3 FTE staff plus 1 space per 5 m ² public floorspace for conference or exhibition facilities plus 1 coach space per 100 bedrooms (minimum)	1 l/t space per 20 beds 1 l/t space per 10 staff
Small hostel (single parent or couple with no children)	0.75 spaces per unit	1 l/t space per 3 units
Family hostel (two adults and two children)	1 space per unit	
C2		
Institutions / homes with care staff on premises at all time ²	1 space per 5 resident bed spaces plus 1 space per 2 non-resident staff	1 s/t space per 20 beds 1 l/t space per 10 staff
Frail Elderly Accommodation ^{2,3}	1 space per 4 resident bed spaces	
Hospitals	To be assessed on a case by case basis	
Education – Halls of Residence	1 space per 2 FTE staff plus 1 space per 6 students	1 l/t space per 3 students 1 l/t space per 10 staff
D1		
Public halls and places of assembly (not D2)	1 space per 9 m ² or 1 space per 3 fixed seats plus 3 spaces per 4 FTE staff	1 s/t space per 200 m ² 1 l/t space per 10 staff
Community and family centres	1 space per 9 m ² plus 1 space per FTE staff	
Day centres	1 space per 9 m ² or 1 space per 4 visitors plus 1 space per FTE staff	
Places of worship	1 space per 10 m ²	
Surgeries and clinics (including doctors, dentists and vets)	3 spaces per consulting room 1 space per FTE non-consultant staff	1 s/t space per consulting room 1 l/t space per 10 staff

¹ Restaurant and bar floorspace will be subject to A3 and A4 standards respectively if open to non-residents.

² Resident staff to be assessed at general needs housing standard.

³ Defined as per Housing Corporation's Scheme Development Standards: "Extra Care supported accommodation, which may be either shared or self-contained, for frail older persons. Includes warden or 24 hour emergency care, the full range of communal facilities, plus additional special features, including wheelchair user environments and supportive management". Other Extra Care housing will be considered against the C3 parking requirements unless it can be demonstrated that it is specifically for frail older persons.

Use Class / Type	Required number of car parking spaces (includes visitor spaces unless otherwise stated)	Minimum cycle parking standard
Libraries	2 spaces plus 1 space per 30 m ² public floorspace	1 s/t space per 100 m ² 1 l/t space per 10 staff
Nursery schools / playgroups	1 space per 4 pupils	1 l/t space per 10 staff
D1 (continued)		
Schools (including residential)	1 space per FTE staff plus 1 space per 5 full-time further education students plus 1 space per 8 students over 17 years of age plus 1 space per 20 students aged 17 years or less plus 1 visitor space per 100 students	1 l/t space per 15 students (primary) 1 l/t space per 5 students (further education and secondary) 1 l/t space per 5 staff
Further education	1 space per FTE staff plus 1 space per 5 full-time students	1 l/t space per 5 students 1 l/t space per 10 staff
D2⁴		
Places of entertainment	1 space per 5 m ² 0.75 spaces per FTE staff	1 s/t space per 25 m ² 1 space per 10 staff
Multi-screen cinemas	1 space per 3 seats on free standing development	1 s/t space per 20 seats 1 l/t space per 10 staff
Swimming and leisure pools	1 space per 10 m ² public floorspace 1 space per 2 FTE staff 2 coach spaces (minimum)	1 s/t space per 25 m ² 1 space per 10 staff
Tennis / badminton courts	2 spaces per court	
Squash courts	2 spaces per court	
Gyms and health clubs	1 space per 7 m ² public floorspace	
Ice rink	1 space per 12 m ² rink area	
Ten pin bowling	3 spaces per lane	1 s/t space per 3 lanes / rink 1 s/t space per 25 spectator seats 1 l/t space per 10 staff
Football pitches	20 spaces per pitch 1 space per 5 paying spectators (where there is fixed or temporary seating)	2 s/t space per pitch

⁴ Additional cycle parking provision will be required where it is anticipated that children may be expected to use proposed facilities without accompanying adults (see paragraph 5.13).

Use Class / Type	Required number of car parking spaces (includes visitor spaces unless otherwise stated)	Minimum cycle parking standard
Other outdoor pitches	1 space per 2 users (maximum potential usage) 1 space per 5 paying spectators (where there is fixed or temporary seating)	
Golf course	100 spaces plus 50 overflow (18 holes) 9 holes at 50% of above rates	5 l/t spaces per 9 holes
Golf driving range	1.5 spaces per tee	1 s/t space per 5 tees
Other sports and recreational uses	To be assessed on a site by site basis, dependant on anticipated staffing, levels of use and numbers of paying spectators	
Motor Trade related (Sui Generis)		
Staff	0.75 spaces per FTE staff	1 l/t space per 10 staff
Showroom and car sales	1 space per 10 cars displayed	
Vehicle storage	2 spaces per showroom space or 10% of annual turnover	
Hire cars	1 space per 2 cars based on site	
Ancillary vehicle storage	3 spaces or 75% of the total if more than 3 vehicles	
Workshops	3 spaces per bay	
Tyre / exhaust centres	2 spaces per bay	
Parts store / sales	3 spaces for customers	
Car wash / petrol filling ⁵	3 waiting spaces per bay	

Car parking for disabled people

Use Class / Type	Minimum Parking Standard
Employment Generating Development	
Up to 25 parking spaces	2 disabled spaces
26 to 50 parking spaces	3 disabled spaces
51 to 75 parking spaces	4 disabled spaces
76 to 100 parking spaces	5 disabled spaces
Thereafter	1 disabled space for every 50 spaces or part thereof
Shops / Buildings to which the public have access and Public Car Parks	
Up to 25 parking spaces	3 disabled spaces
26 to 50 parking spaces	4 disabled spaces
51 to 75 parking spaces	5 disabled spaces
76 to 100 parking spaces	6 disabled spaces
Thereafter	3 disabled spaces for every 100 spaces or part thereof
Hotels	As for employment generating development or 1 disabled space per room built to mobility standards, whichever is the greater

⁵ Additional spaces for shop required at A1 standard.

- 4.1 The tables on the preceding pages set out the Council's non-residential parking standards. The car parking standards show the required levels of provision in line with guidance in the NPPF and the Core Strategy 2013. The cycle parking standards set out the minimum level of provision.
- 4.2 Outside of the accessibility zones identified below, there will be an initial presumption for the required car-parking standard to be applied. Where necessary, the total level of provision should be rounded to the nearest whole number. Developers proposing car-parking provision above or below the levels identified in this SPD should provide robust evidence to support their case, including where genuine shared car parking opportunities exists. Where a change of use occurs from a Class A1 or Class A2 unit to an eating or drinking establishment, without any increase in floorspace or footprint, the Council recognises that it may not be appropriate to seek the maximum amount of off-street parking.
- 4.3 Appropriate provision should be made for the parking of motorcycles and other powered two-wheel vehicles. As a guide, approximately 5% (1 in 20 spaces) of the required car parking provision (excluding the disabled requirement) should be allocated for motorcycle use. This proportion should be included in the total parking provided for a development rather than in addition to it.
- 4.4 Parking and access requirements for service and delivery vehicles shall be additional to the requirements set out in these standards unless specifically stated. Where required, the quantity and design of Heavy Goods Vehicle (HGV) parking will be assessed on a site-by-site basis.
- 4.5 Further advice on the design and layout of parking provision is given in Section 5.

Accessibility Zones

- 4.6 Non-residential accessibility zones have been specified in the Borough's main towns. These zones have been identified with regard to the availability of journey-to-work public transport services. Maps of the accessibility zones are attached to this SPD.
- 4.7 Applications for new development in these areas should seek to promote the use of walking, cycling and public transport by providing car parking below the maximum levels. The table below indicates the proportions of the maximum car-parking standard that will normally be sought within each zone. Disabled car parking provision should not be subject to discount and should always be provided at the full standard. A worked example is provided in Appendix 2.

Figure 5: Non-Residential Accessibility Zone discounts

Zone	Level of Car Parking Provision (Excluding disabled parking)
1	0 -25%
2	25 -50%
3	50 -75%
4	75 -100%

- 4.8 The upper end of each range will form the starting point for negotiation. Provision below this point, within the specified ranges, should be justified by the applicant and will be assessed having regard to the following criteria (as applicable) and the advice in paragraphs 5.9 to 5.11:
- The impact upon the highway including on street parking conditions;
 - Access to existing public or private car parking facilities;

- The ability of existing Controlled Parking Zones (CPZs) to absorb any additional demand for parking;
- The level of cycle parking provided; and
- The provision of mitigating measures

4.9 Developments that are likely to result in levels of additional on street parking that would be contrary to highway and safety considerations will not be permitted. The Council will consider schemes that propose the shared use of existing car parking facilities where this can be reasonably accommodated. The introduction of a new Controlled Parking Zone to address a shortfall of off-street parking provision will also be considered, together with a financial planning obligation or CIL to the cost of implementing a scheme.

4.10 Where new development is proposed within an existing Controlled Parking Zone and that CPZ has no capacity to absorb additional demand, all parking requirements should be met on site.

4.11 Measures to mitigate against the parking and / or transport impacts of new development may include (but are not limited to):

- On- or off-site highway works to facilitate the use of alternative modes;
- The provision of a Travel Plan
- Section 106 contributions or CIL towards sustainable transport measures (including Greenways routes); or
- Section 106 contributions or CIL towards the development and / or implementation and control of CPZs.

Cycle parking

4.12 The provision of 1 cycle space per ten staff represents a modal share target of 10% of journeys to work. The calculation of provision should be based upon the maximum number of full-time equivalent staff on site at any time.

4.13 The standards expressed are minimums that should be met on all applications for development. Where higher levels of cycle use are anticipated, appropriate provision should be made above the minimum standard if required. In particular, sports and recreational developments that children may be expected to use without accompanying adults (e.g. sports pitches, swimming pools etc) should make additional provision for cycle parking.

4.14 The Council will seek the provision of showers and changing facilities (including lockers) on all major employment (B-class) developments. Developers should make reasonable provision of associated facilities on other non-residential schemes that will employ a significant number of people or have the potential to generate an increased number of journeys to work by bicycle.

4 Design and Layout of Parking Spaces

- 4.1 There are a number of publications providing advice on design and layout that should be considered in conjunction with the SPD and that will be material considerations in the determination of planning applications.
- 4.2 Hertsmere's Planning and Design Guide was adopted as a Supplementary Planning Document in November 2006. Part D of the guide provides guidelines on design considerations and criteria for new developments, including car-parking areas. The relevant advice is reproduced on the following page and should be considered in conjunction with the standards in this SPD.
- 4.3 Hertfordshire County Council published Building Futures, an advisory sustainable development guide, in August 2006. The Water module should be referred to for additional advice on the use of sustainable drainage systems and (semi) permeable surfacing. The guide can be downloaded from <http://www.hertsdirect.org/yrccouncil/hcc/env/plan/issues/buildingfuturessustainability/>.
- 4.4 Roads in Hertfordshire – A Guide for New Development was published in 2001 and contains technical advice on the detailed transport aspects of residential or commercial development. Prospective developers should refer to those standards in conjunction with the advice contained in this SPD.
- 4.5 The Department for Communities and Local Government and the Department of Transport jointly published the Manual for Streets in March 2007. This document contains detailed advice and guidance on the layout of streets in new development.

Car Parking

- 4.6 Parking areas should make a positive contribution to the design and setting of development with bays a minimum of 2.4 x 4.8m in dimension. Adequate space must be provided for turning and manoeuvring.
- 4.7 Where new houses are proposed, the preference will be for car parking to be provided within the curtilage of the individual dwelling. Where car parking is to be provided adjacent to a home designed to lifetime home standards, the space should be capable of enlargement to a width of 3.3m in accordance with Lifetime Homes standards.
- 4.8 Where garages are provided, these should have minimum internal dimensions of 3 x 4.8m (or multiples thereof) to ensure that they can provide sufficient space for the storage of cars. Garages that do not meet these dimensions will not count towards car parking provision. Where appropriate, the Council will remove permitted development rights on new residential developments to prevent the conversion of garages to additional habitable rooms.
- 4.9 When communal parking is proposed, schemes where all parking spaces are allocated to individual properties will be resisted. In such instances, a proportion of the car parking spaces required by these standards should remain unallocated to make allowance for different levels of ownership and visitor requirements. Undercroft parking will be supported where it does not adversely affect the appearance of a development or the wider streetscene and where it meets secure by design principles.
- 4.10 Gated residential developments will be resisted unless exceptional circumstances exist. Gated developments can create a sense of segregation, reduce connectivity between developments and can increase fear and perception of crime and will be resisted by the Council. The installation of high security gates to the front of individual properties can have a similar effect and will also be resisted. Parking layouts will be expected to reduce

opportunities for crime and incorporate secure by design principles, as set out in Part D of the Planning and Design Guide (section 8.3). In consultation with Hertfordshire Constabulary, the Council will seek s106 or CIL funding for CCTV, where appropriate, as well as encouraging developments to achieve Park Mark Safer Parking Awards accreditation. The Building Futures 'safety module' should also be taken into consideration.

- 4.11 Impermeable surfaced or paved areas should be minimised. Permeable solutions should be used wherever practicable to minimise additional surface water run-off into stormwater drainage networks. All proposals involving large areas of car parking should contain sufficient amounts of permeable surfacing, as well as appropriate soft landscaping in accordance with the provision of the Planning and Design Guide.

Hertsmere Planning and Design Guide – Supplementary Planning Document (June 2013)

metres wide. This could be achieved through providing grass verges adjacent to the parking space. Garages should be a minimum of 3.0 x 4.8 metres.

Design of car parking areas

- j. Car parking layout and design is to be carried out in accordance with the guidance issued by the Highway Authority (the County Council) and Local Plan documents.
- k. Parking facilities for residential developments should be well overlooked by buildings with adequate lighting. The design should not provide hiding spaces or enclosures that are intimidating or increase the potential for crime.
- l. Boundaries around private car parking areas should create a clear boundary between private and public space.



- m. The design of any paved parking, garages or vehicle access areas should be integrated into the streetscape and should not be visually dominating or detract from the appearance of the development frontage. Off-street car parking should be located either to the rear, to the side, underneath or above of buildings. Off-street car parking to the side or rear of buildings should be broken up into small groups of no more than 6 spaces to avoid large, concentrated areas of car parking and should be well overlooked with an appropriate lighting scheme. Any on-street car parking should be also be broken up into small clusters of spaces, separated by areas of pavement, street furniture and / or planting.
- n. Large areas of impermeable paving should be avoided. Porous or open block paving is generally preferred, which should be broken up with soft landscaping. **The Council is likely to refuse applications that do not provide porous surfaces where large areas of parking are provided.**

- o. The main entry to a building for pedestrians should not be directly through car parking spaces or driveways.
- p. Communal parking spaces should be suitably delineated. Sufficient spaces within a development for each property should be provided; the Council may seek to achieve this through a planning condition or legal agreement.



Figure 18: Access to building through area of car parking

- q. Access roads and driveways should minimise the intrusion of vehicle lights into homes and other sensitive uses.
- r. Parking can be provided underground or through an under-croft design in order to achieve more efficient use of the site. The design of underground and under-croft car parking should:
 - Minimise the visual impact of the entrance to the street;
 - Maximise pedestrian safety and maintain pedestrian access;
 - Provide access for people with a disability; and
 - Provide safe and secure, well-lit storage for vehicles.



Figure 19: Undercroft parking

Ⓞ Design tip:
 Providing car parking on a communal basis, rather than on a basis exclusive to a particular property can make better use of the spaces provided and accommodate different car ownership levels. Consideration should be given to achieving the ACPO Park Mark award where communal car parking is proposed.

- 4.12 To reduce flood risk and encourage biodiversity, residential developments should avoid the use of hardstanding that covers the entire front garden area. The conversion of front gardens to hardstanding will be discouraged. Where appropriate, the Council will remove permitted development rights on new residential developments to achieve this.

Disabled Car Parking

- 4.13 Disabled parking bays should extend beyond the standard minimum dimensions of 2.4 x 4.8m. Bays should be provided at right angles to the access aisle, with an additional width of 1.2m to be provided along each side. This strip can be shared where disabled bays are provided adjacent to one another. There should also be a 1.2m safety zone at the access end of each bay. These measures are to allow safe access to both sides of the vehicle and the boot, creating a total minimum bay size of 3.6m x 6m.
- 4.14 Where this arrangement is not possible and bays are to be provided parallel to the access aisle, an additional 1.8m should be added to the length of each bay.
- 4.15 Disabled bays should be well lit and signed and / or marked. Bays should be as close as possible to the main entrance of the building and must be provided within 50 metres. The route from the disabled parking bays to the entrance must be free from steps, steep slopes or other obstructions. Disabled bays should not double up as 'parent and baby' parking spaces.
- 4.16 Further information is provided in the Department for Transport's Traffic Advisory Leaflet 05/95: Parking for Disabled People and Inclusive Mobility, both available from www.dft.gov.uk.

Motorcycle Parking

- 4.17 Areas for motorcycle parking should be covered, well drained with no, or only a slight, gradient. A non-slip surface should be provided. Any parking bays or areas should provide a means for securing motorcycles and powered two-wheelers. Both ground level and raised points can be considered, provided they are designed so as not to create an obstruction or trip hazard to pedestrians.
- 4.18 Fixed features including rails, hoops or posts that provide a locking point should be considered. A footprint of 2.0m x 0.8m should be allowed for each motorcycle.
- 4.19 Further information on forms of storage and security is provided in the Department for Transport's Traffic Advisory Leaflet 02/02: Motorcycle Parking, available from www.dft.gov.uk.

Cycle Parking

- 4.20 Where parking provision is to be made within the curtilage of the individual dwelling, secure provision (e.g. garage / shed or similar) should be made for the storage of bicycles. A floorspace requirement of 1.25m x 2m will apply for each bicycle. Where applicable, it may be necessary to provide garages at above the minimum dimensions set out in paragraph 5.8 in order to accommodate both cars and bicycles, although secure, covered communal cycle parking will be acceptable, where this does not adversely affect the layout and appearance of the development. On particularly large commercial developments, typically in excess of 2,500 sq m, cycle parking requirements may be relaxed to avoid prejudicing the overall design of a development through the allocation of excessive numbers of cycle parking spaces.

- 4.21 For communal cycle provision, Sheffield or Camden 'M' stands (or similar) are considered satisfactory. One Sheffield stand will be counted as two cycle parking spaces provided that the requirements set out below are met.
- 4.22 Sheffield stands (or similar) should be 800-1200mm in length and not more than 800mm in height. A space of at least 1000mm should be provided between the midpoint of each stand with a gap of at least 550mm on all sides between stands and walls or other obstructions. Stands should be securely affixed to the ground, preferably through the use of submerged fixings. A flat, bound surface that is well drained should also be provided.
- 4.23 Short term cycle parking provision should:
- Be well lit;
 - Be conveniently located within a short distance of the building entrance and, where possible, offer a real advantage over the nearest available car parking space
 - Allow for natural surveillance;
 - Be sited away from bin stores (or other features that may deter use) and;
 - Be clearly signed on non-residential developments.
- 4.24 Long-term cycle parking provision should meet the criteria in Paragraph 4.23 and, in addition, be covered, lockable and secure (e.g. a dedicated cycle shed or pen). An indicative cycle store layout is provided in Figure 6.

Figure 6: Sheffield stands and indicative cycle store layout (plan view)

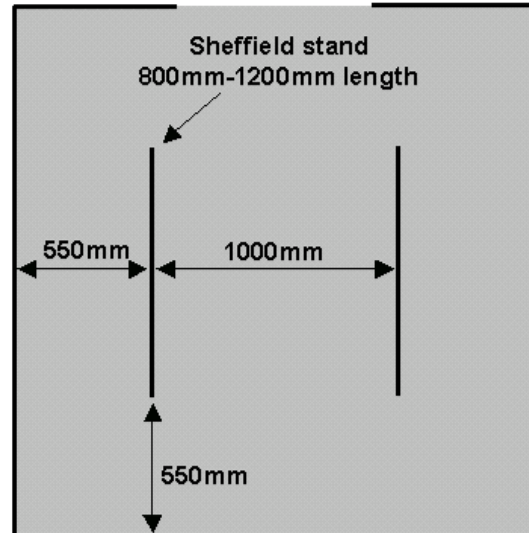
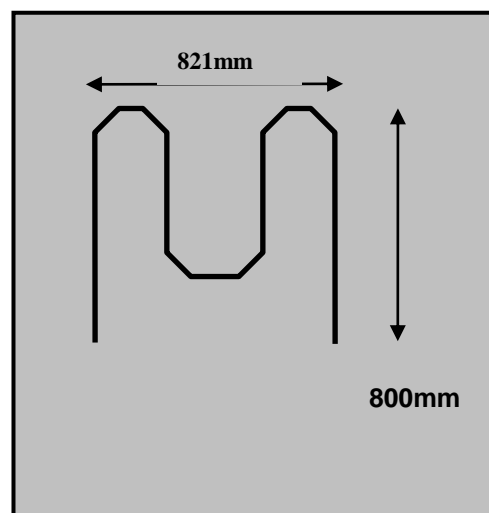

Figure 7: Camden 'M' stand and indicative elevation



4.25 Further detailed information on forms of storage and security is provided in the Department for Transport's Traffic Advisory Leaflet 05/02: Key Elements of Cycle Parking Provision, available from www.dft.gov.uk and Hertfordshire County Council's Cycle Parking Guide.

5 Travel Plans

- 4.26 The NPPF promotes Travel Plans as a means of reducing car usage and increasing use of public transport, walking and cycling.
- 4.27 The Council will require the submission of a robust Travel Plan on all Major non-residential developments (as defined in statute) and on significant new residential developments providing 100 or more dwellings (gross) before granting planning permission or discharging the associated condition. A Travel Plan will also be sought on other schemes where the achievement of a modal shift is considered to be particularly necessary.
- 4.28 Travel Plans should deliver a range of measures and incentives to facilitate the use of alternative modes of transport. These measures should be based on a thorough understanding of the actual or projected travel movements of employees, residents and students (for educational establishments). Clear targets should be set to allow the Travel Plan to be monitored and reviewed. In the event that agreed, tangible targets contained in the Plan are not met, enforcement action will be considered by the Council.
- 4.29 A checklist has been developed to assess the content of submitted Travel Plans. This is set out in Appendix 3. Travel Plans that do not provide reasonable consideration of the issues in the checklist will not be considered fit for purpose.
- 4.30 Further information on employer, school and residential Travel Plans is provided in good practice guidance published by the Department for Transport, available from www.dft.gov.uk. Further guidance on green travel alternatives is also available from Hertfordshire County Council via www.hertsdirect.org/.

6 Section 106 and CIL Contributions for Highways and Transport

- 4.31 The council will collect CIL upon the introduction of a CIL Charging Schedule and where appropriate, the Council will seek Section 106 and / or Section 278 obligations to deliver improvements to highways and transport infrastructure that are directly related to a proposed development. Planning obligations will be sought in accordance with the provision of the CIL Regulation 2010 (as amended).
- 4.32 Obligations for highways and transport improvements may include (but are not limited to) contributions and / or works towards the following:
- On-site or off-site highway improvements
 - Public Transport improvements
 - Other sustainable transport measures (e.g. cycle paths alongside existing roads)
 - Community Transport (including both Dial-a Ride and voluntary car scheme)
 - Greenways (generally shared routes for cycling, equestrian and pedestrian use)
 - Parking improvements and / or security measures in the vicinity of the site
 - Development and / or implementation and control of CPZs
 - Air quality monitoring
- 4.33 Local Area Transport Plans have either been adopted, or are in preparation, for Borehamwood & Elstree, Bushey and Potters Bar. These plans identify key schemes and areas of work in Hertsmere's main towns. The Watling Chase Greenways Strategy identifies a proposed network of routes for non-motorised users (walkers, cyclists and horse riders). These documents will be used to guide requests for Section 106 contributions from new development.
- 4.34 Additional information on Section 106 requirements is contained in Hertsmere's Planning Obligations SPD, which should be referred to by potential developers. This document, which is regularly updated, sets out the current formulae and thresholds used to calculate Section 106 contributions on new developments.

7 Transport Assessments

- 4.35 The effect of the traffic that is likely to be generated by new development will, in certain circumstances, need to be comprehensively examined to allow the determination of planning applications. Potential developers should consult with Hertfordshire County Council (the Highway Authority) to agree on the existing conditions near the development site and the need for any formal Transport Assessment to be prepared.
- 4.36 Transport Assessments should be submitted alongside a planning application for the following types and size of development (areas are gross floor space measured externally, unless otherwise stated):
- Residential Development in excess of 25 units
 - Retail development of more than 2000m²
 - Development in classes B1, B2, or B8 of more than 2000m² and
 - Developments for sports centres, leisure facilities and golf courses and practise ranges.
- In addition to the development types listed above, Transport Assessments should also be produced:
- Where traffic levels to and from the proposed development are likely to exceed 5% of the two-way traffic flow on the adjoining highway from which it takes access
 - Where traffic congestion exists or will exist within the assessment period; and
 - In sensitive locations (e.g. adjacent or close to traffic lights or roundabout junctions).
- 4.37 Where a Transport Assessment is not submitted, developers should be able to satisfactorily demonstrate that these requirements have been tested.
- 4.38 Further information on the requirements for Transport Assessments is contained in Roads in Hertfordshire, which prospective developers should refer to in conjunction with the advice contained in this SPD. Contact details for the highway authority are provided in the following section.
- 4.39 The Department for Transport and Department for Communities and Local Government have also published Guidance on Transport Assessment. This document should also be referred to in the development of any Transport Assessment.

8 Contact Details

4.40 If you require further information on any of the details or criteria contained in this supplementary planning document, please contact Hertsmere's Planning Policy Team using the details provided below.

Planning and Building Control Unit,
Hertsmere Borough Council,
Civic Offices,
Elstree Way,
Borehamwood
Hertfordshire
WD6 1WA

General enquiries: E: planning@hertsmere.gov.uk
T: 020 8207 2277

Section 106: Monitoring and Research Officer
T: 020 8207 2277 extn. 5885

Travel Plans: Policy and Transport Team
T: 020 8207 2277
or Principal Planning Officer (Policy) (details as above)

School Travel Plans: School Travel Plan team (Hertfordshire County Council)
T: 01992 556125

4.41 For enquiries relating to specific sites or development proposals, please contact the Development Control area team leaders (postal address as above):

Elstree / Potters Bar Team
(covering Elstree, Borehamwood, Shenley,
Ridge, South Mimms and Potters Bar)
Development Team Manager (Elstree /
Potters Bar)
E: planning@hertsmere.gov.uk
T: 020 8207 2277

Bushey / Aldenham Team
(covering Bushey, Bushey Heath,
Aldenham, Radlett, Letchmore Heath,
Patchetts Green and Roundbush)
Development Team Manager (Bushey /
Aldenham)
E: [planning @Hertsmere.gov.uk](mailto:planning@Hertsmere.gov.uk)
T: 020 8207 2277

4.42 For enquiries relating to highways matters, please contact the Highways Service at Hertfordshire County Council:

Hertfordshire County Council
County Hall
Pegs Lane
Hertford
Herts
SG13 8DN
T: 01992 555555

Appendix 1: Policy Background

In preparing this SPD, regard has been given to the wider policy context and these documents have helped to guide the development of the objectives set out in Section 1 and the detailed standards set out in this draft SPD.

The National Planning Policy Framework (NPPF) requires Local Development Documents to demonstrate consistency with national policy and general conformity with the regional spatial strategy. The document must also be founded on a credible evidence base and have due regard to the authority's Community Strategy and any other relevant plans, policies and strategies.

National policy

National planning policy is set out in the NPPF . The key guidance relating to travel choice and parking is contained in:

- Section 4 on 'Promoting sustainable transport'
- Plan Making for Infrastructure in paragraph 162

The NPPF promotes a reduction in the use of the private car, an increase in the use of walking, cycling and public transport and the use of car parking standards as a means of reducing journey lengths.

The NPPF includes a requirement for plan policies to mitigate the effects of climate change through the reduction of harmful emissions and a need to promote more healthy lifestyles. It also encourages policies that reduce the need to travel and promote alternative modes of transport.

The NPPF also states that residential car parking standards should be developed with regard to likely levels of car ownership at new developments. Section 2 of the NPPF encourages a position that new developments for town centre uses (retail, offices, leisure, entertainment and the arts) should be well connected to other uses. In determining applications, local authorities should assess the relationship between the proposed development and public transport facilities as well as considering the needs of pedestrians, cyclists and the disabled.

The NPPF requires authorities to use parking policies, alongside other measures, to promote sustainable transport choices and reduce reliance on the private car. The guidance requires development plan policies to set evidence base parking standards while at the same time increasing the quantity and quality of cycle and motorcycle parking in new developments.

The use of public transport and journeys by foot are also promoted by the NPPF. The guidance advocates the use of travel plans as a means of reducing car use and advises that local authorities should consider setting local targets for the number of plans to be adopted.

A number of recent Government-commissioned reports have highlighted the need to implement proactive measures to combat emissions and climate change. In particular, the Eddington Transport Study⁶ highlights the link between vehicle use and harmful emissions.

The Government has produced a wide range of good practice guidance that has been referred to in developing this SPD. This includes Department for Transport advisory leaflets on the provision of cycle and motorcycle parking and good practice guidance on the development and implementation of Travel Plans.

⁶ 'Transport's role in sustaining UK's Productivity and Competitiveness: The Case for Action' (Sir Rod Eddington, 2006)

Local policy and guidance

Hertfordshire's second Local Transport Plan (LTP3) was published in May 2011. Amongst its key objectives are the management of the growth of transport and to encourage use of more sustainable modes of transport. A number of complementary strategies have also been introduced promoting rail, buses, road safety and better accessibility planning respectively.

Area-based transport plans have either been adopted, or are in preparation, for Borehamwood & Elstree, Bushey and Potters Bar. These contain a mixture of measures to improve road safety and encourage the use of alternative modes. These plans identify key schemes and areas of work and will be used to guide requests for Section 106 contributions from new development.

The County Council have produced good practice guidance on the development of travel plans and a Cycle Parking guide, providing detailed advice on methods of provision.

A Review of the Hertsmere Together Community Strategy was published for 2013-2016. Key objectives relevant to this SPD include

- **To improve and sustain the quality of Hertsmere's environment.** This objective includes an aim to improve road safety and obtain the best use of the existing highways network.
- **To promote healthier communities and leisure and cultural opportunities.** This objective includes an aim to improve opportunities for people to engage in a healthy, active lifestyle.

Much of Hertsmere lies within the Watling Chase Community Forest. In 2003, the Borough Council produced the Watling Chase Greenways Strategy and has also adopted Supplementary Planning Guidance on the Watling Chase Community Forest. These documents aim to promote greater use of non-motorised travel and create a network of routes within and between urban areas for both leisure and utility journeys.

As well as the Local Plan, the Planning and Design Guide, as well as the Building Futures 'safety module', contain relevant advice connected with parking layouts.

Census and car parking survey results

Hertsmere has historically displayed levels of car ownership above the national average. Results from the 2001 Census⁷ showed average car ownership in Hertsmere to be 1.35 vehicles per household, which increased to 1.391 in the 2011 Census. In 2001 this was higher than the average figure for the East of England region (1.27 vehicles per household) and England as a whole (1.11 vehicles per household).

Census data shows that the population has grown from 94,450 in 2001 to 100,031 in 2011, which is an increase of 5.91%. The number of cars or vans in Hertsmere has grown at a faster rate compared to population growth at an increase of 7.79%, from 51,324 in 2001 to 55,324 in 2011. Meanwhile household size remains steady at 2.5 people per household.

The data showed a clear differentiation in levels of ownership between different housing tenures, with ownership amongst owner-occupiers more than twice that of households who socially rent their properties. More details can be found in Figure 7.

⁷ Table KS17: Cars or Vans. Office for National Statistics (ONS). © Crown Copyright.

Figure 7: Car ownership by tenure, 2011

	% of households with		
	No car	1 car	2 or more cars
Hertsmere	17%	41.6%	41.3%
Owner Occupied	16.1%	44.6%	39.3%
Shared Ownership	4.0%	35.3%	60.6%
Social rented	40.7%	43.5%	15.8%

Source: 2011 Census, ONS

Travel to work data from the census⁸ showed that more than 65,000 journeys to work occur within the Borough. Of these, the majority were undertaken by private car. More than 6,000 individuals were recorded as living and working in the same ward in Hertsmere whilst more than 27,000 journeys were recorded between Hertsmere and its neighbouring Boroughs. More than half of these journeys are undertaken by car indicating significant opportunities to promote the use of alternative modes on shorter journeys.

Approximately 1.5% of journeys to work beginning and ending in the Borough were undertaken by bicycle. 1.3% was undertaken by motorcycle or other powered two-wheeler.

⁸ Table T10: Theme Table on Resident, Workplace and Daytime Population. ONS. © Crown Copyright.

Appendix 2: Worked Examples

Example 1

- Scheme type: Residential (C3)
- Size / Type: 14 units: 8x2 bed flat, 6x1 bed flat.
- Parking type: Communal
- Residential Accessibility Zone: None

Step 1: Identify the maximum standards for the unit type and size

- 1 bed flat: 1.5 spaces per unit = 9 spaces
- 2 bed flat: 2 spaces per unit = 16 spaces
- Total = 25 spaces

Step 2: Identify the disabled parking requirement

- 10% of provision, rounded to the nearest number, should be available for disabled use.
- This results in a requirement for 3 spaces (rounded up from 2.5)

Step 3: Identify the discount

- Outside of the identified accessibility zones, there is a presumption for the maximum standard to be applied.

Step 4: Identify the provision for motorcycle parking

- 5% of the required car parking provision (1 in every 20 spaces) should be allocated for motorcycles and other powered two-wheel vehicles, rounded to the nearest whole number.
- Excluding disabled provision, 22 car parking spaces are required. At least one space should therefore be allocated and designed appropriately for motorcycles.

Step 5: Add back on the disabled parking

- 25 parking spaces should be provided. Of these, 21 should be standard car parking spaces with 1 motorcycle bay and 3 disabled spaces.

Step 6: Calculate the minimum cycle parking requirements

- A minimum of one long-term space per unit should be provided.
- A cycle store (or similar) with room for at least 14 cycles should be provided.
- In addition, one short term cycle storage space should be provided per five units. This would result in a requirement for three spaces.
- If the applicant wishes propose a lower level of car parking, it may be suitable to seek a higher level of cycle parking provision.

Example 2

- Scheme type: Offices (B1a)
- Size / Type: 1200m²
- Accessibility Zone: 2

Step 1: Identify the maximum standards for the unit type and size

- 1 space per 30m² = 40 spaces

Step 2: Identify the disabled parking requirement

- 40 spaces on an employment generating development would require the provision of 3 disabled bays.

Step 3: Identify the discount

- For development in Zone 2, the range is 25-50% of the maximum standard. The disabled provision is not subject to discount so the reduction should be applied to the remaining 37 bays. This results in a requirement for between 9.25 and 18.5 spaces.
- The general presumption will be to impose the upper end of the range rounded to the nearest whole number. In this case, this will result in a requirement for 19 spaces.

Step 4: Identify the provision for motorcycle parking

- 5% of spaces (1 in every 20) of the required car parking provision should be allocated for motorcycles and other powered two-wheel vehicles, rounded to the nearest whole number.
- 19 car parking spaces are required. At least one space should therefore be allocated and designed appropriately for motorcycles.

Step 5: Add back on the disabled parking

- 22 parking spaces should be provided (though as few as 12 may be acceptable depending on the circumstances and the criteria outlined in Section 5)
- Of these, 18 should be standard car parking spaces with 1 motorcycle bay and 3 disabled bays).

Step 6: Calculate the minimum cycle parking requirements

- 1 short term space per 500m² = 3 spaces (rounded to nearest whole number)
- 1 long-term space per 10 staff. The applicant should supply sufficient information to allow this provision to be calculated on a site-by-site basis.

Appendix 3: Travel Plan Checklist

Does the TP consider the policy background? Including (as appropriate):

Background documents and issues

- Climate change/C02 emissions/air and noise pollution
- Health issues – obesity, stress, effect of vehicular emissions, etc.
- Are You Doing Your Bit “A Travel Plan Resource Pack for Employers”
- HTCOA “Developing a Green Travel Plan: A Guidance Note”
- DETR “A New Deal for Transport: Better for Everyone”
- DETR “School Travel Strategies and Plans”
- Social Exclusion Unit “Making the Connection: Final Report on Transport and Social Exclusion”

Planning policy documents

- National Planning Policy Framework
- Local Plan / Local Development Framework policies
 - Draft Core Strategy Policies: SP1, CS21, CS22, CS23
 - Local Plan Policies: M1, M2, M5, M6, M8, M9, M11
- Supplementary Planning Guidance / Documents
 - Parking standards
 - Watling Chase Community Forest
- Watling Chase Greenways Strategy
- Local Transport Plan
- Local Area Transport Plans
 - Borehamwood
 - Potters Bar
 - Bushey / South-West Herts
- Hertfordshire County Council Cycle Parking Guidelines
- For larger developments (e.g. a business park) applicants should also be aware of DfT’s various good practice guidance (available from www.dft.gov.uk)

Does the TP evaluate the existing situation? Including (as appropriate)

- Descriptions of pedestrian and cycle routes available to (within close proximity of) the site
- Descriptions of cycle facilities already made available either in the immediate area or as a condition of development e.g. racks, showers, lockers and crossings
- Descriptions and frequencies of available bus routes
- Details of nearest train stations and route availability / frequency
- Details of nearest services and facilities

Does the TP provide baseline data (e.g. through a staff survey)? Including (as appropriate)

- Analysis of employee / customer catchment area
- Analysis of existing or predicted travel patterns to / from the site including modal choice
- Analysis of latent demand and factors that would encourage modal shift

Does the TP consider a suitable range of initiatives or provide reasoned justification as to why initiatives cannot be pursued in the location? Including (as appropriate)

Promotional measures

- Appointment of a TP co-ordinator
- Public transport publicity (including display of timetables, provision of link to intalink website <http://www.intalink.org.uk/> from all PC desktops etc)
- Working with bus, train and community transport operators on possible initiatives or marketing
- Car share database

- Promotional material relating to walking / cycling
- Staff meetings and updates

Incentives

- Season ticket loans / discounts
- Bike purchase loans / subsidies.
- Regular visits by bike doctor
- 'Cycle buddy' scheme (or similar)
- Payment of cycle mileage rates (at equal or preferential rates to car mileage)
- Remote working/homeworking with attendant ICT link-ups and dial-ins

Provision

- Secure bike storage / lockers / showers (if not already a condition of the development)
- Pool cars / car club
- Pool bikes (including folding bikes)
- Bus or minibus to / from key destinations
- Parking spaces reserved for car sharers and / or disincentives for single occupancy car drivers i.e. charging
- Dedicated motor cycle parking provision
- On- or off-site improvements to reduce the need to travel or facilitate the use of alternative modes (or Section 106 contributions to allow these to be implemented).
- Additional schemes / measures appropriate to the development type proposed. Examples could include:
 - Walking buses for schools
 - Group trip buses for theatres
 - Discounts / loyalty card points for customers in retail schemes

Does the TP set a range of targets, and are these targets measurable (e.g. based on numbers / percentages rather than aspirational)? Could include (as appropriate)

- % reduction in single occupancy car journeys
- Number / % of journeys as a passenger in a car
- Number / % of journeys by modes other than the private car (broken down into journeys by bike, foot, public transport)
- Subscribers to the car share database
- Use of pool cars / office bikes / staff bus / car club vehicles (as provided)
- Number of season tickets purchased with the aid of a loan / subsidy
- Number of bikes purchased with the aid of a loan / subsidy
- Staff / resident awareness of the Travel Plan and initiatives
- % of staff homeworking / number of days spent homeworking

Does the TP recognise the benefits of implementation?

- Benefits employer / employees: Health (physical and mental wellbeing), retention, less sickness leave, ISO9000 benefits, better neighbours etc
- Wider benefits: Reduced congestion, less pollution / CO2 emissions, wider environmental benefits

Does the TP make provision for monitoring and review?

Does the TP contain penalty measures in the event that agreed targets are not met?

Appendix 4: Accessibility Zones Methodology

A grid of approximately 40,000 points was created by plotting a point every 50 metres north-south and east-west across the Borough. The accessibility of each of these points to public transport facilities and key local services has been assessed.

This assessment has been used to inform the draft accessibility zones for the Borough. These zones identify those areas where a reduced level of car parking provision may be considered acceptable.

Scoring the component parts: Accessibility to public transport services (bus)

A map layer containing bus stops in the Borough was obtained from Hertfordshire County Council (HCC). All bus routes in the Borough were then mapped on top of these, following the routes shown on maps downloaded from Intalink (www.intalink.org).

From this, the number of services passing through each stop could be calculated and, using timetables, the number of services per hour during the AM peak (7-9am), the daytime (9am-5pm), the PM peak (5-7pm) and the evening (7-11pm).

The number of services provided by each route was weighted to reflect its relative connectivity i.e. the likelihood of being able to use that service to reach an end destination. The weightings used were as follows:

Service type	Weighting
Through Bus Route*	100%
Local Bus Route**	50%

* Through bus routes were defined as those routes serving two or more distinct settlements within the Borough or a service connecting any point within Hertsmere to any settlement outside the Borough Boundary

** Local Bus Routes were defined as those routes operating wholly within one settlement within the Borough (e.g. circular services)

A 300m buffer was then created around the bus stops on each of the routes. Mapping exercises showed that this 'as-the-crow-flies' distance most accurately reflected a 400m walking distance from each stop. The catchment buffers were adjusted to take account of any notable physical barriers that would preclude access to the nearest stop (e.g. railway lines with no means of crossing).

Scoring the component parts: Accessibility to public transport services (train)

Using timetables from the Silverlink and First Capital Connect websites, the number of train services passing through stations in Hertsmere was calculated. Bushey, Garston and Watford Town Centre stations were also included as, although they lie outside the Borough boundary, their catchment covered a number of properties in the south-west corner of Hertsmere.

The catchment of each station was assessed by drawing 'ped-sheds' from each station along main roads and footpaths. Two catchment distances, 800m and 1200m, were identified with the number of services available from each station weighted according to these distances.

Distance	Weighting
Train station within 800m walk	200%
Train station between 800m and 1200m walk	100%

Scoring the component parts: Accessibility to local services

Accessibility maps were produced by Hertfordshire County Council using Accession Software showing access to the following services across the Borough: Primary School, Secondary School, Food Shop, GP Surgery and Significant Retail Centre (Town Centres, Local Town Centres and District Centres as defined in the Hertsmere Local Plan).

For each point on the grid, the number of these services within 10 minutes walking time (800m) was calculated.

Translating the scores into accessibility zones

These results were then translated into accessibility zones using the criteria set out in the tables below. Firstly, the non-residential zones were created by identifying groups of points that met the following criteria, based upon services available in the AM peak:

Criteria	Zone
Minimum of 24 public transport services per hour (weighted) within walking distance including : <ul style="list-style-type: none"> ➤ Station(s) with peak period service of <u>at least</u> 1 train every 15 minutes (each direction) within 800m walk; and ➤ Bus stop(s) with a peak period service of <u>at least</u> 1 bus every 15 minutes (each direction) within 400m walk. 	1
Minimum of 20 public transport services per hour (weighted) within walking distance including : <ul style="list-style-type: none"> ➤ Station(s) with peak period service of <u>at least</u> 1 train every 20 minutes (each direction) within 1200m walk; and ➤ Bus stop(s) with a peak period service of <u>at least</u> 1 bus every 20 minutes (each direction) within 400m walk. 	2
Minimum of 16 public transport services per hour (weighted) within walking distance including : <ul style="list-style-type: none"> ➤ Bus stop(s) with a peak period service of <u>at least</u> 1 bus every 30 minutes (each direction) within 400m walk. 	3
Minimum of 12 public transport services per hour (weighted) within walking distance including : <ul style="list-style-type: none"> ➤ Bus stop(s) with a peak period service of <u>at least</u> 1 bus every 30 minutes (each direction) within 400m walk. 	4

N.B. Bus service frequency calculated after the weightings outlined above have been applied.

These zones then formed the basis of the residential zones, with an additional allowance made for the scores for accessibility to local services. Zones were formed by groups of points meeting the following criteria:

Residential Accessibility Zones		Non-Residential Zone		
		1-2	3	4
Number of local services	4+	2	3	4
	3	3	4	4*
	2	4		Zone

* Borehamwood and Potters Bar only

Accessibility zones have been created by connecting adjacent points in the same banding that formed a meaningful group (i.e. they were not in a straight line or covering a very small area). The zones have then been altered to take plot boundaries and other features into account.

Appendix 5: Residential Accessibility Zones within Hertsmere

Contents

Map 1: Borehamwood (centre)

Map 2: Borehamwood (Elstree Way / Manor Way)

Map 3: Bushey (High Street)

Map 4: Bushey (Vale Road / Aldenham Road)



Map 5: Bushey Heath

Map 6: Potters Bar (Darkes Lane / Mutton Lane)

Map 7: Potters Bar (High Street / Southgate Road)

Map 8: Radlett

These maps detail Residential Accessibility Zones in Hertsmere. These areas have good access to public transport and key services. Applications for new residential development in these areas should seek to promote the use of walking, cycling and public transport by providing car parking below the maximum levels set out in the SPD

Key		
	Zone	Level of maximum car parking provision
	2	25-100%
	3	50-100%
	4	75 - 100%

Map 1: Borehamwood (centre)

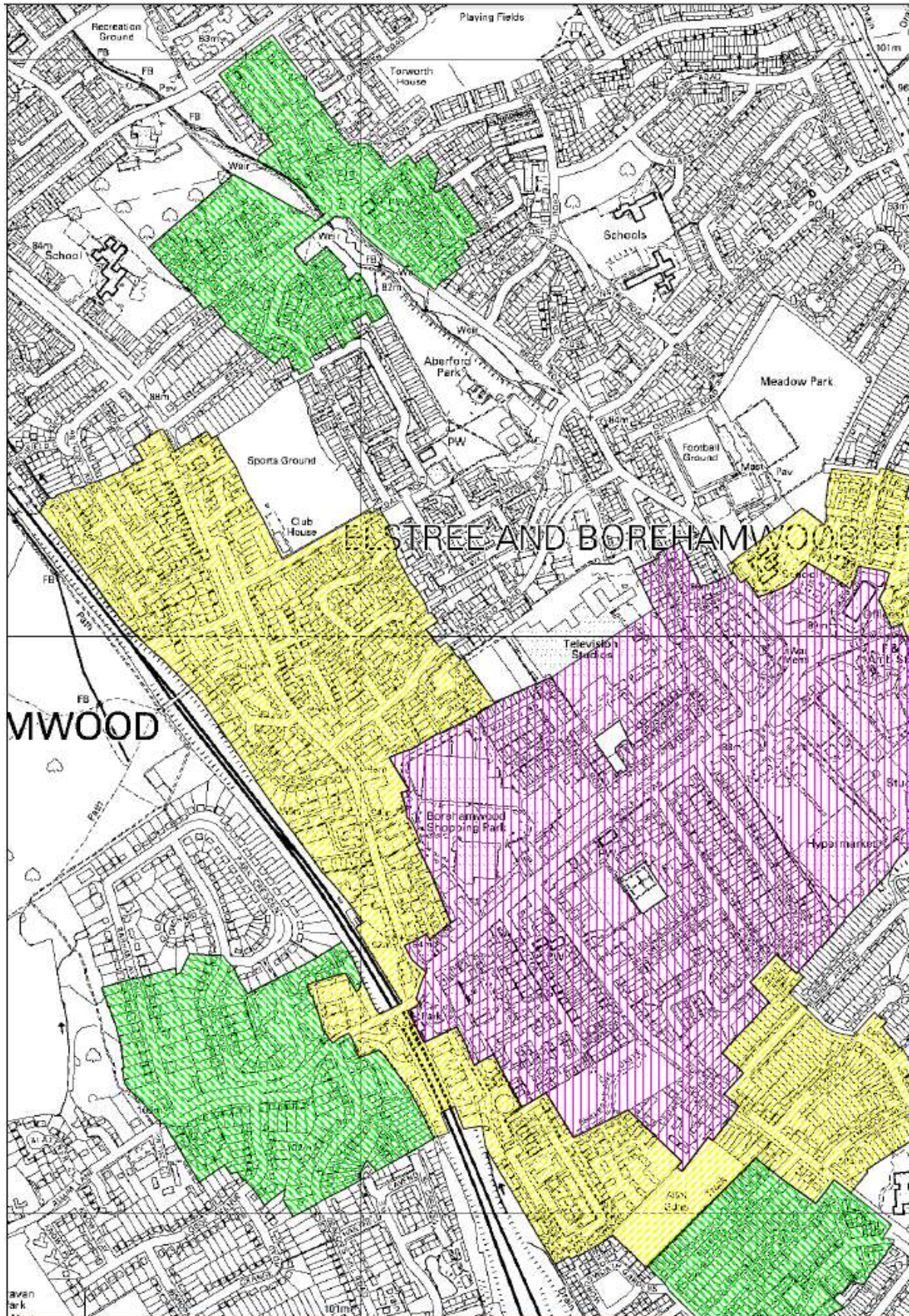

Map 2: Borehamwood (Elstree Way / Manor Way)

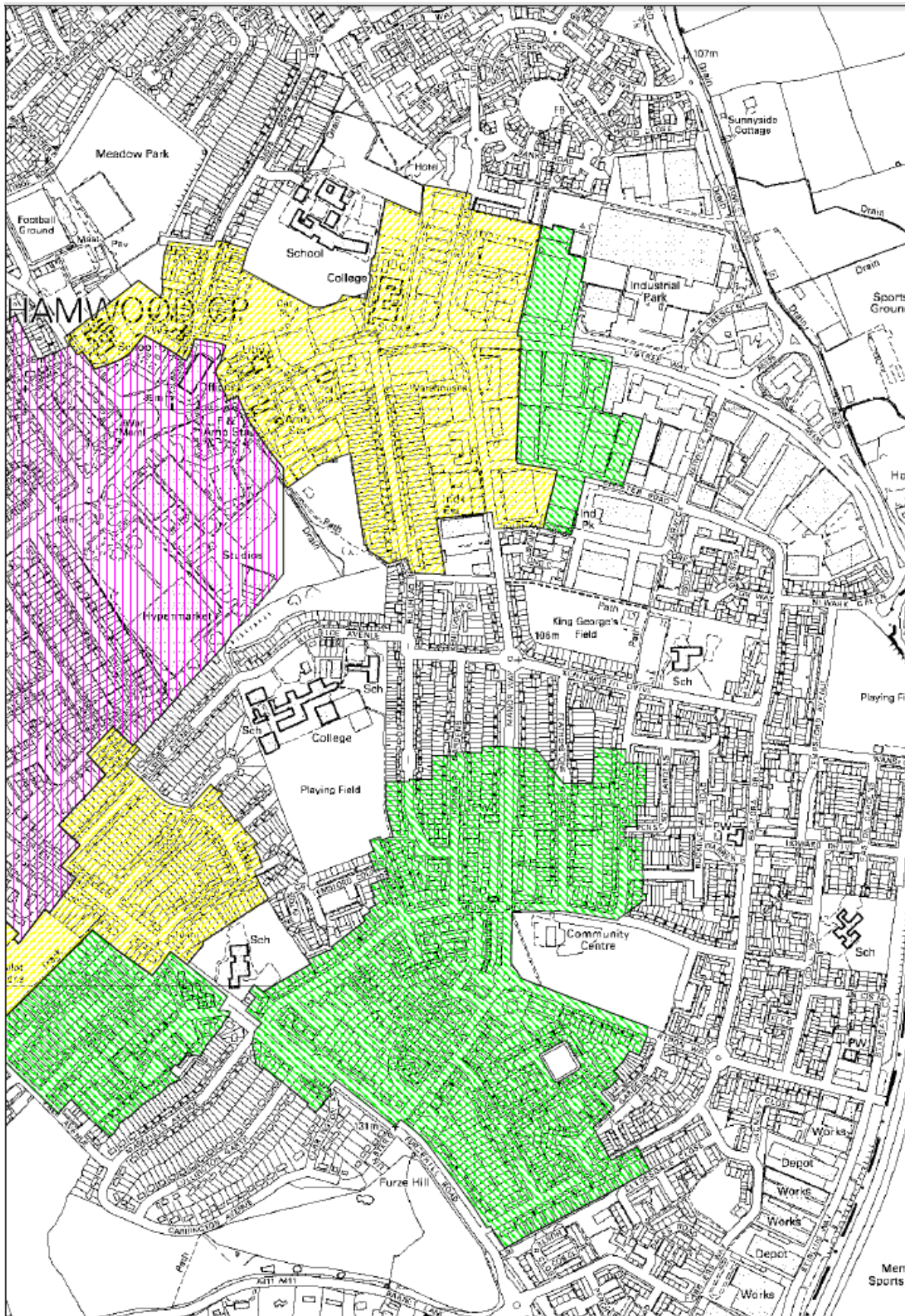

Map 3: Bushey (High Street)

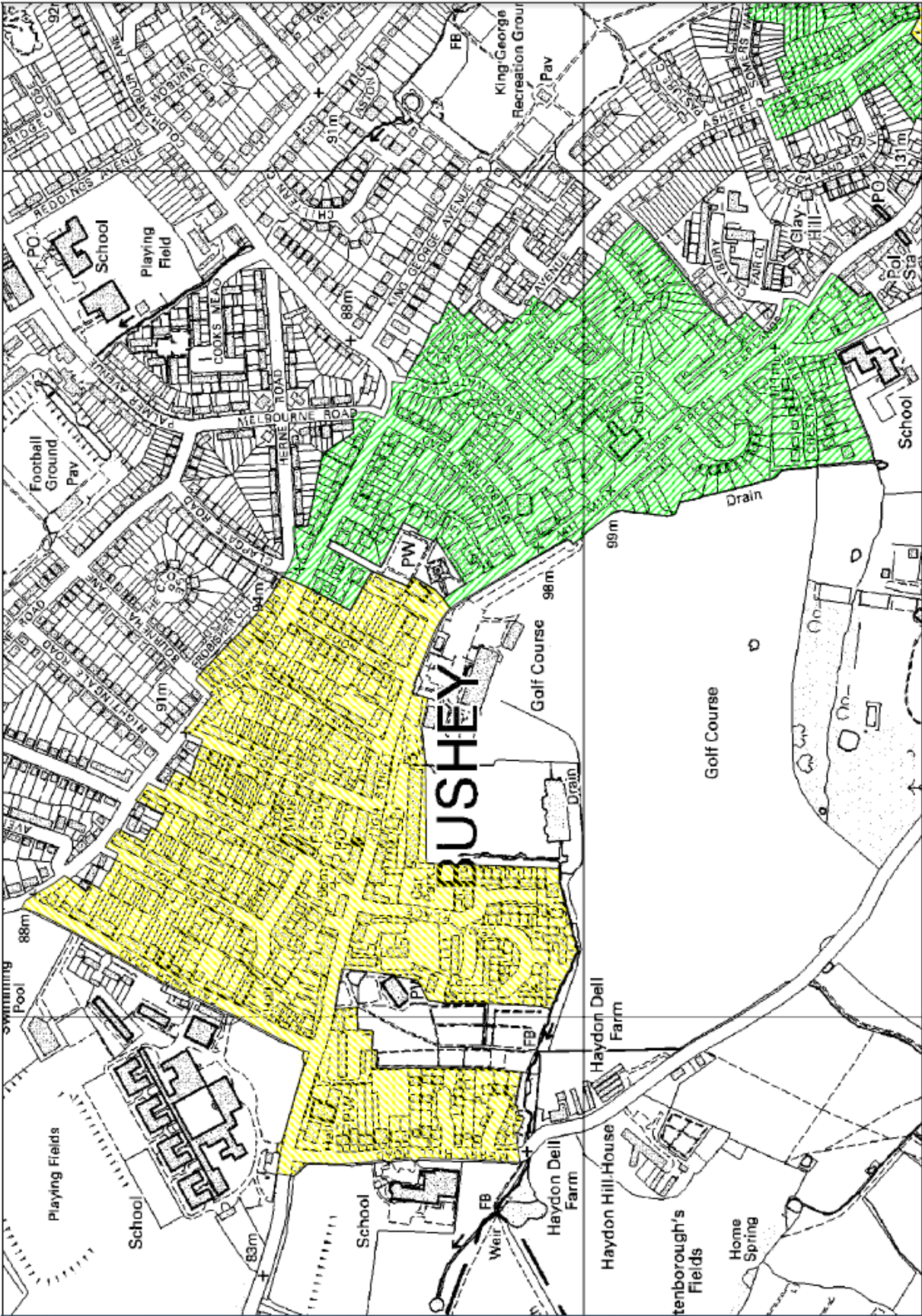

Map 4: Bushey (Vale Road / Aldenham Road)

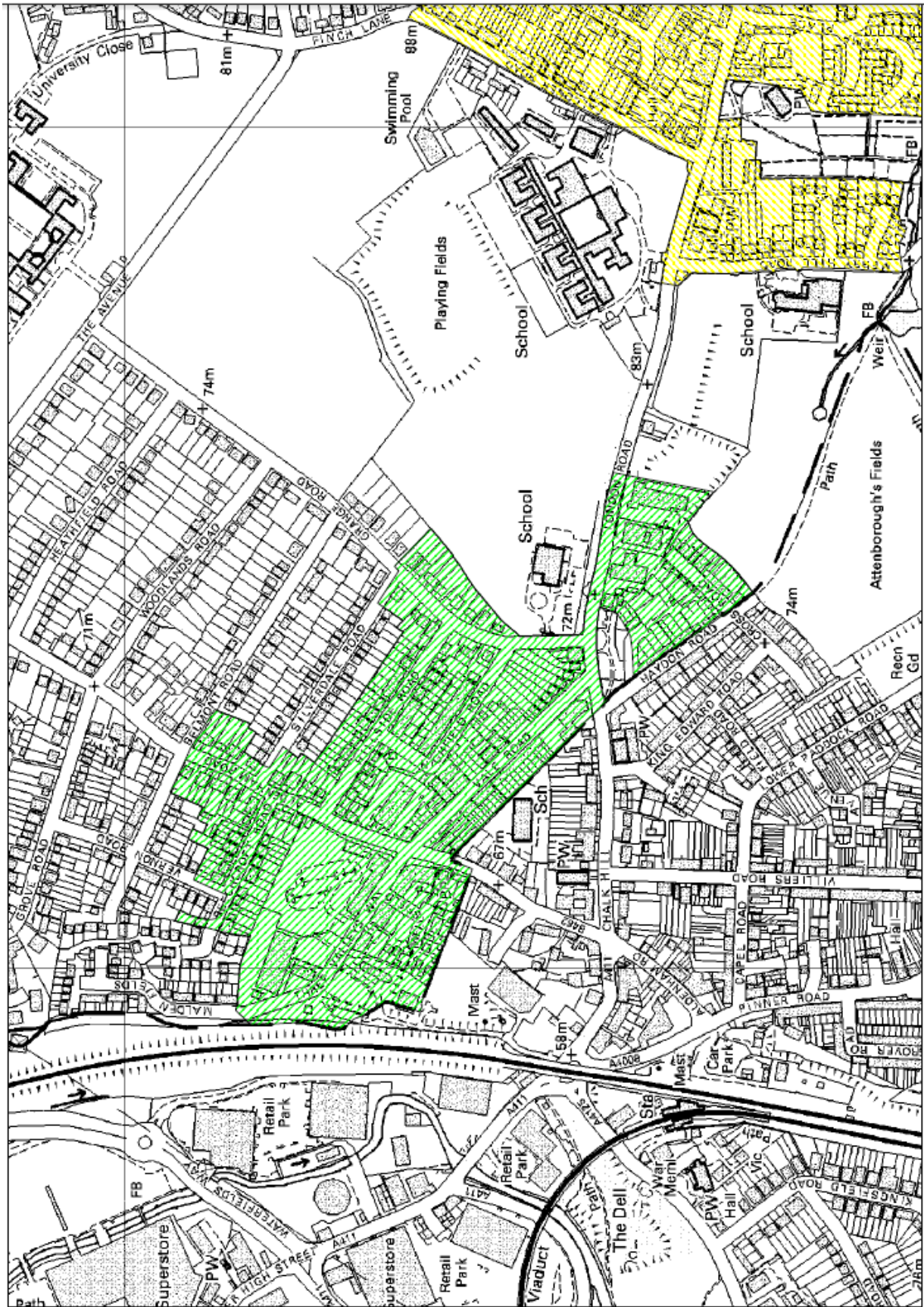

Map 5: Bushey Heath

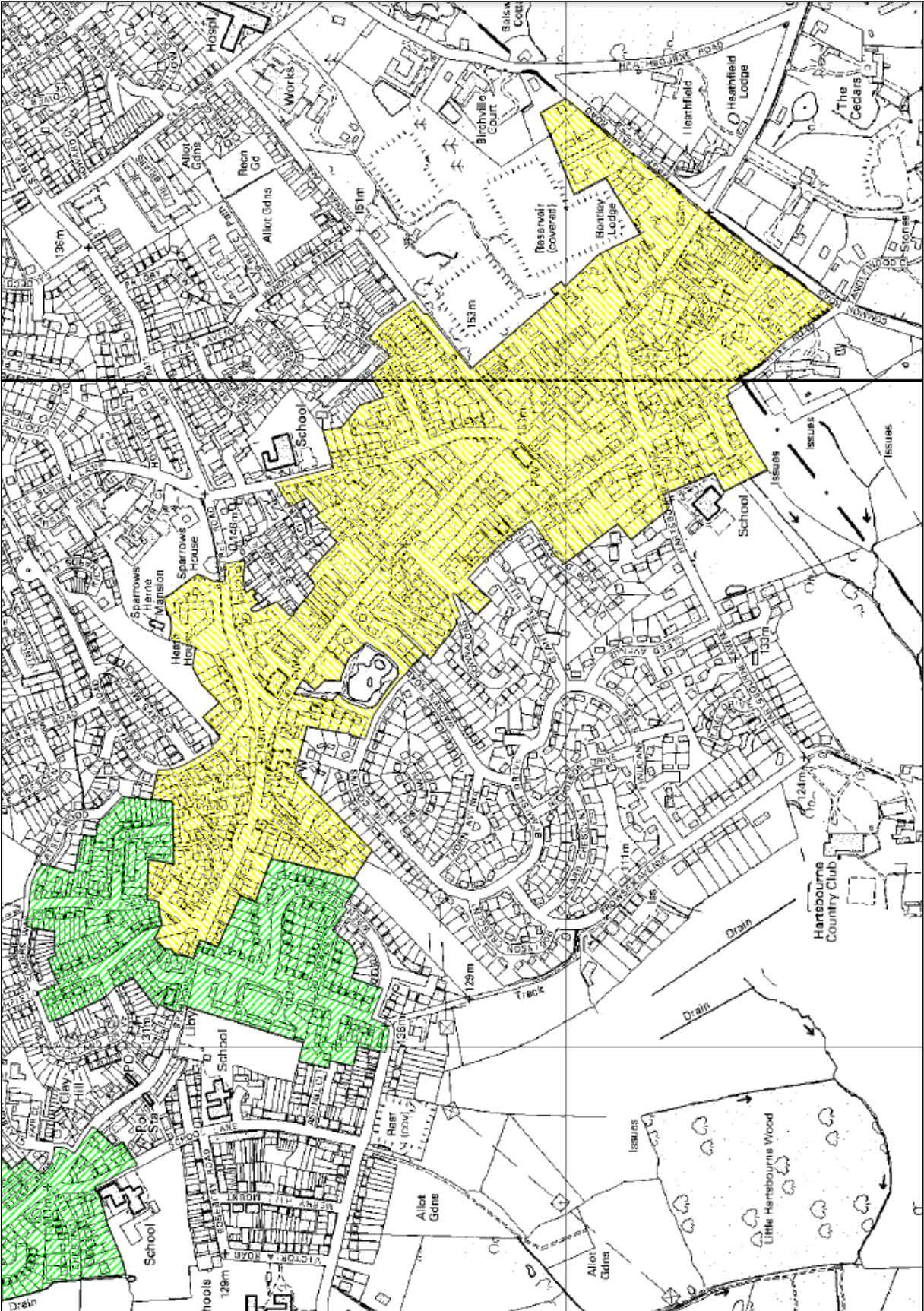

Map 6: Potters Bar (Darkes Lane / Mutton Lane)

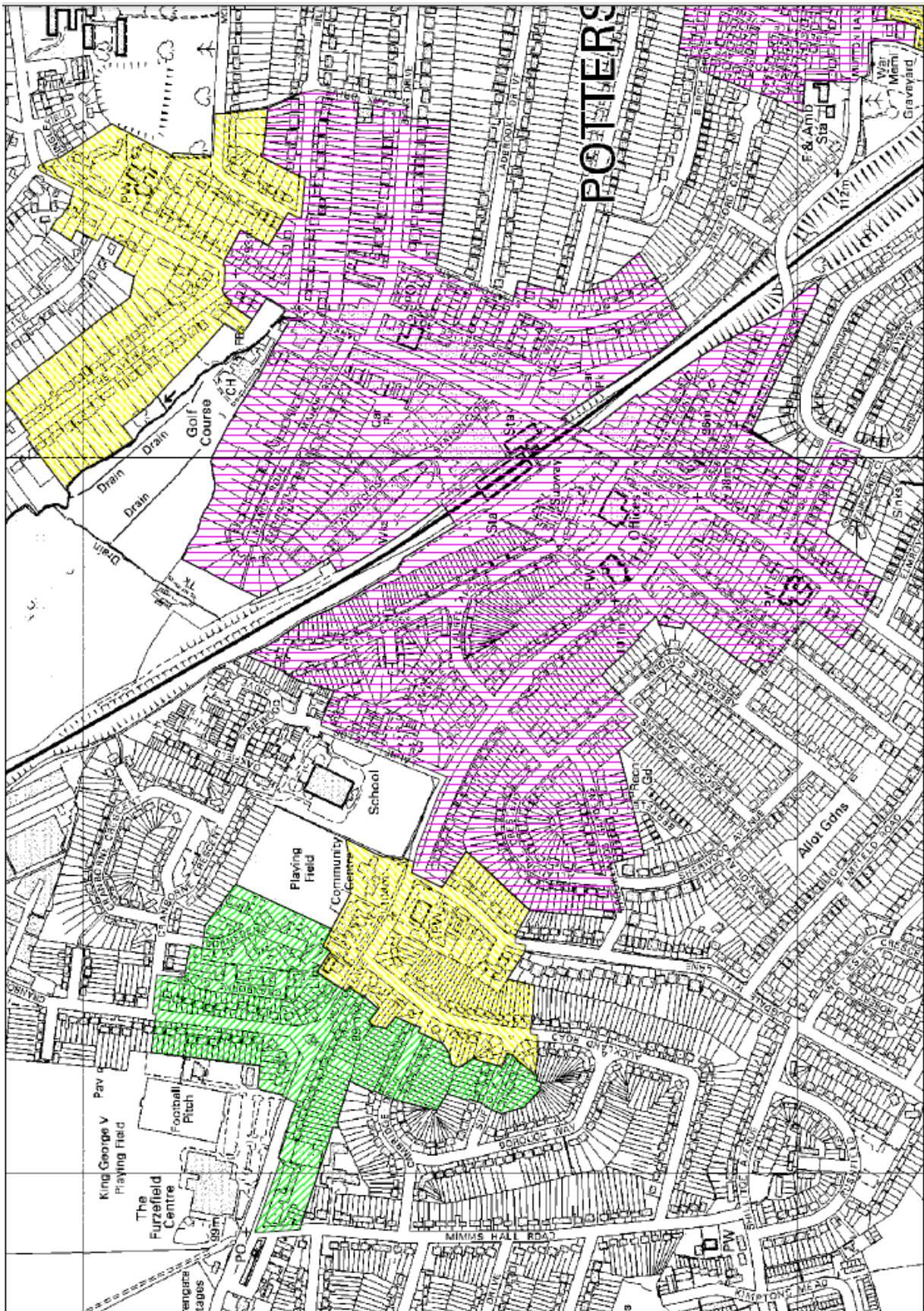

Map 7: Potters Bar (High Street / Southgate Road)

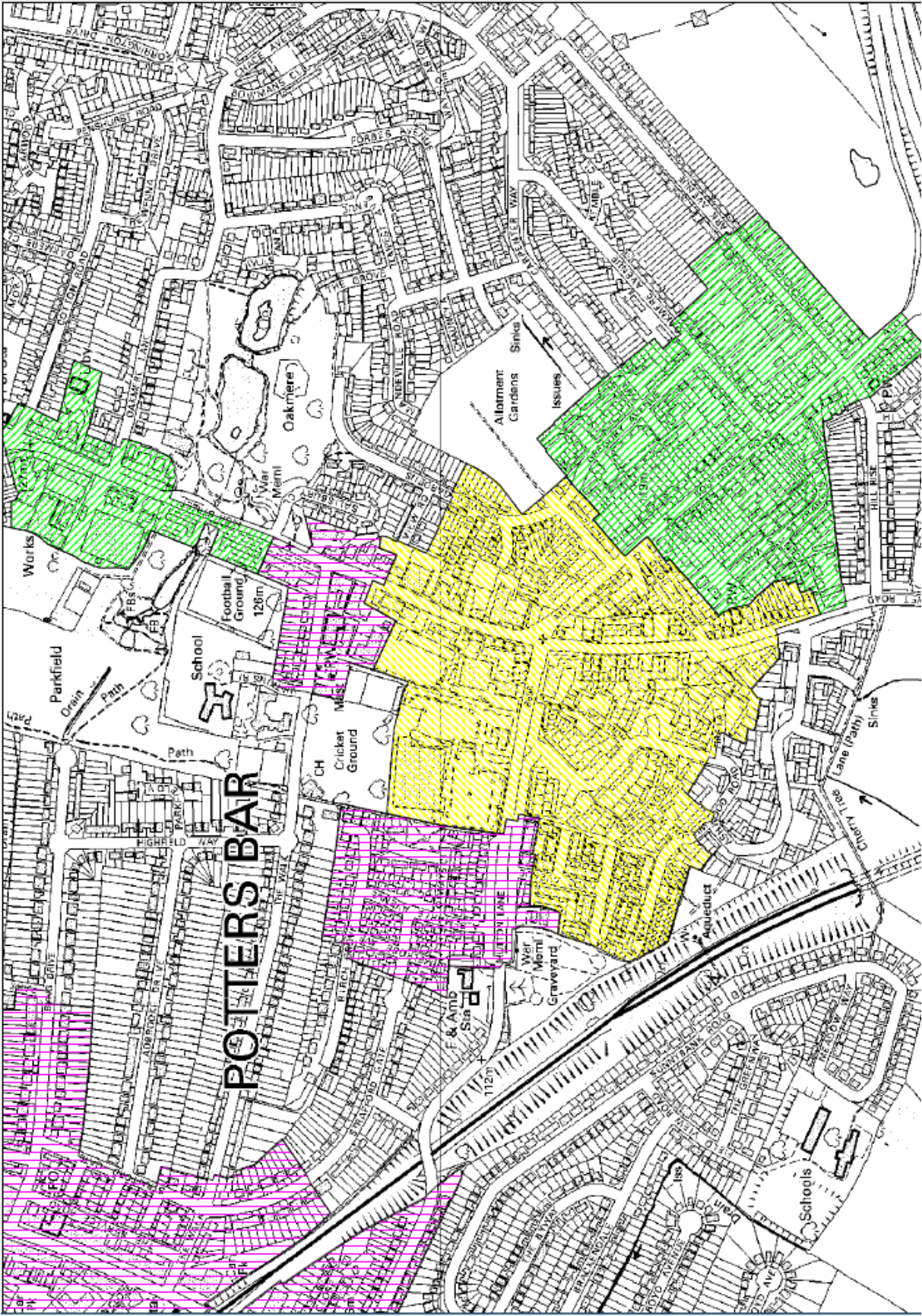

Appendix 6: Non-Residential Accessibility Zones within Hertsmere

Contents

Map 1: Borehamwood (centre)

Map 2: Borehamwood (Elstree Way / Manor Way)

Map 3: Bushey (High Street)

Map 4: Bushey (Aldenham Road)





Map 5: Bushey Heath

Map 6: Potters Bar (Darkes Lane / Mutton Lane west)

Map 7: Potters Bar (Mutton Lane east / Southgate Road)

Map 8: Radlett

These maps detail Non-Residential Accessibility Zones in Hertsmere. These areas have good access to public transport services. Applications for new non-residential development in these areas should seek to promote the use of walking, cycling and public transport by providing car parking below the maximum levels set out in the SPD.

Key		
	Zone	Level of maximum car parking provision
	1	0-25%
	2	25-50%
	3	50-75%
	4	75-100%

Map 1: Borehamwood (centre)

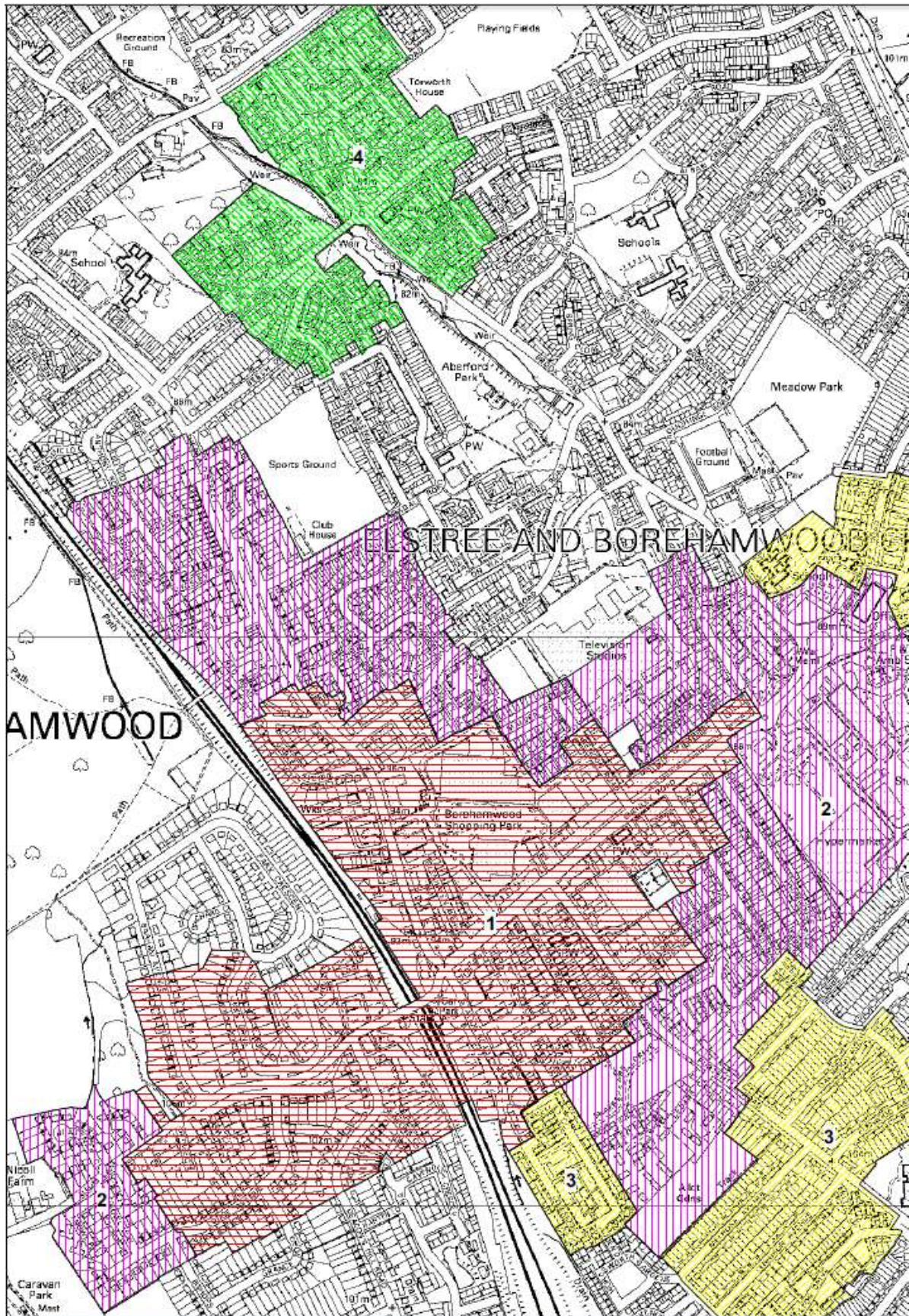

Map 2: Borehamwood (Elstree Way / Manor Way)

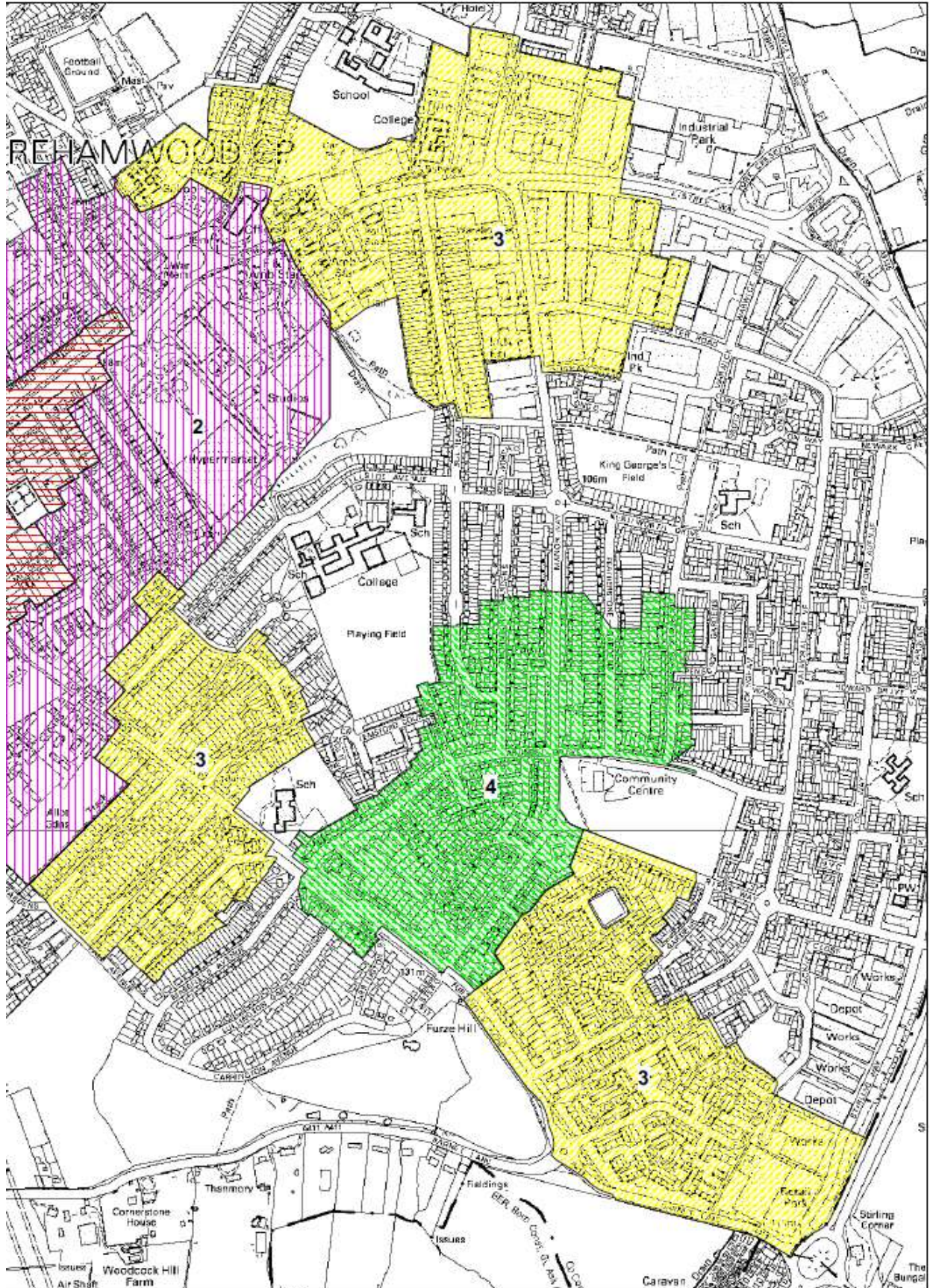

Map 3: Bushey (High Street)

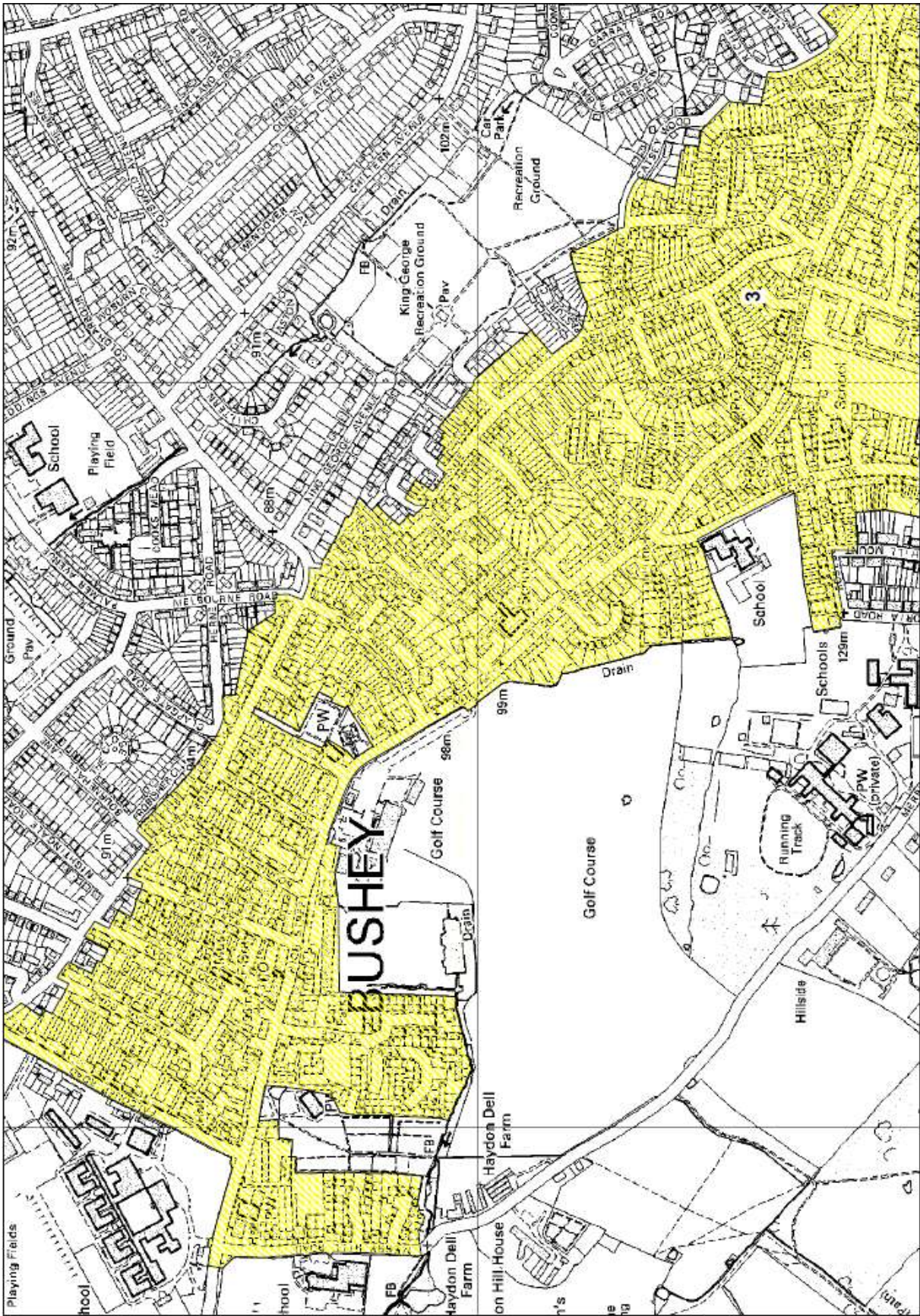

Map 4: Bushey (Aldenham Road)

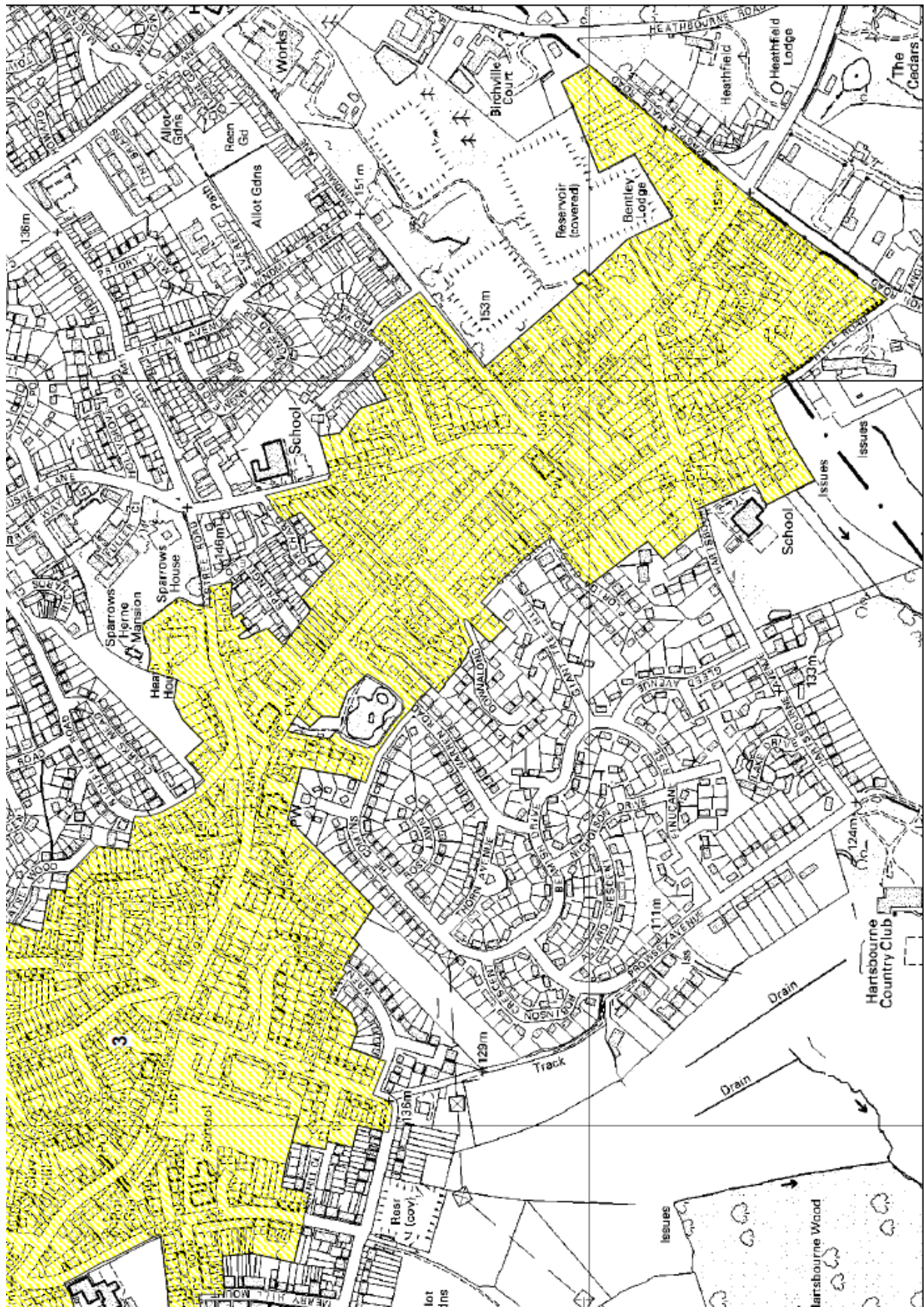

Map 5: Bushey Heath

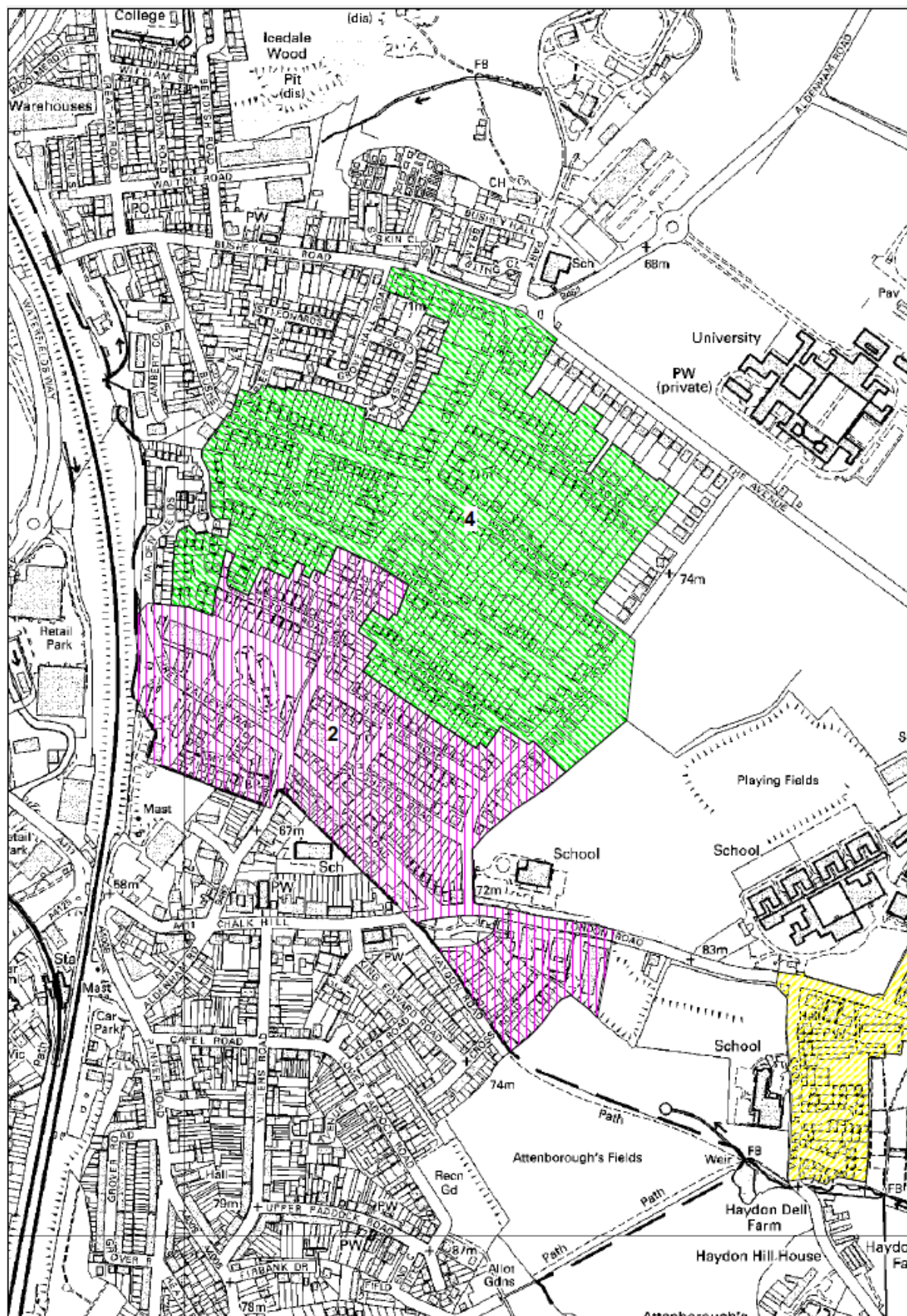

Map 6: Potters Bar (Darkes Lane / Mutton Lane west)

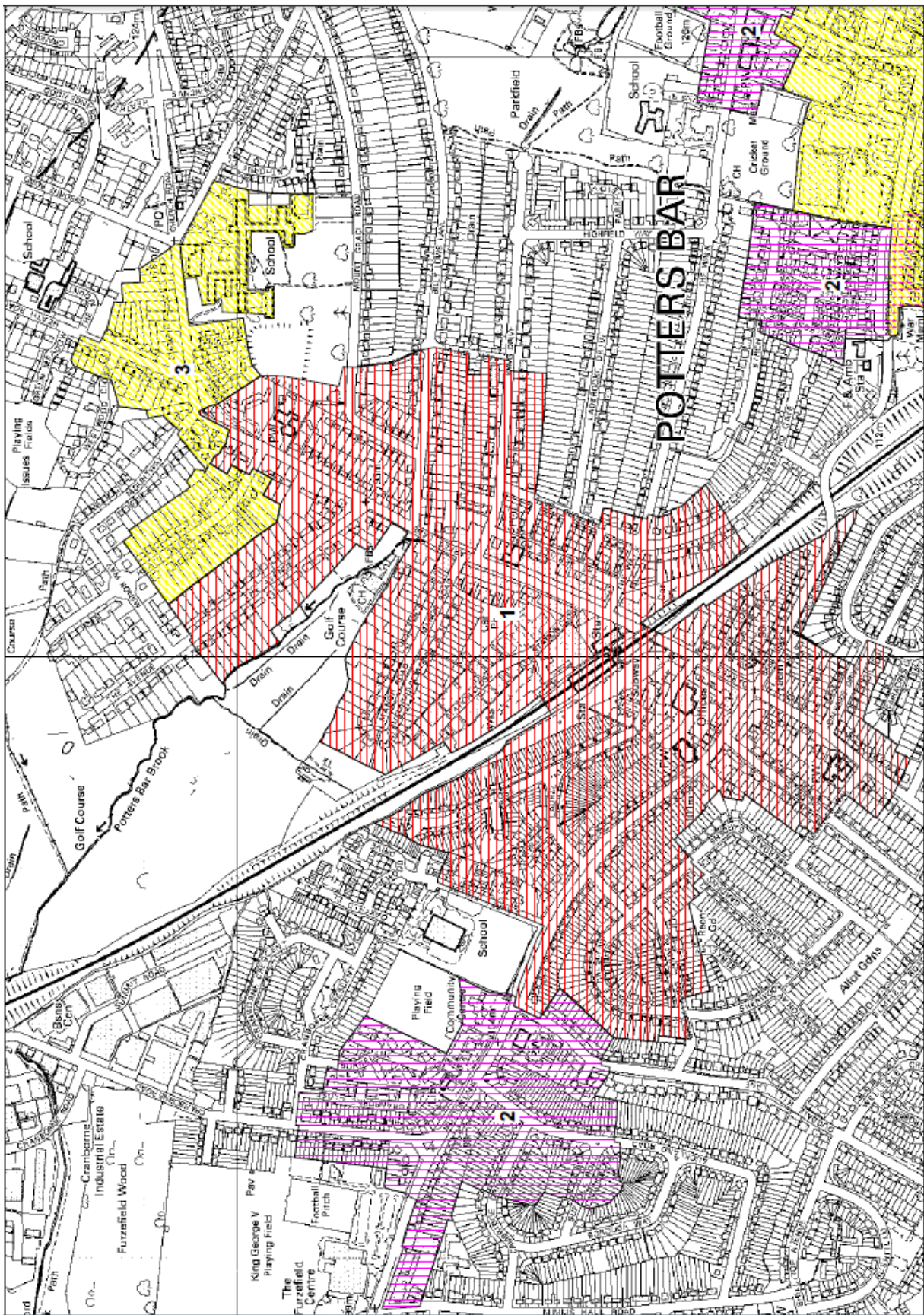

Map 7: Potters Bar (Mutton Lane east / Southgate Road)

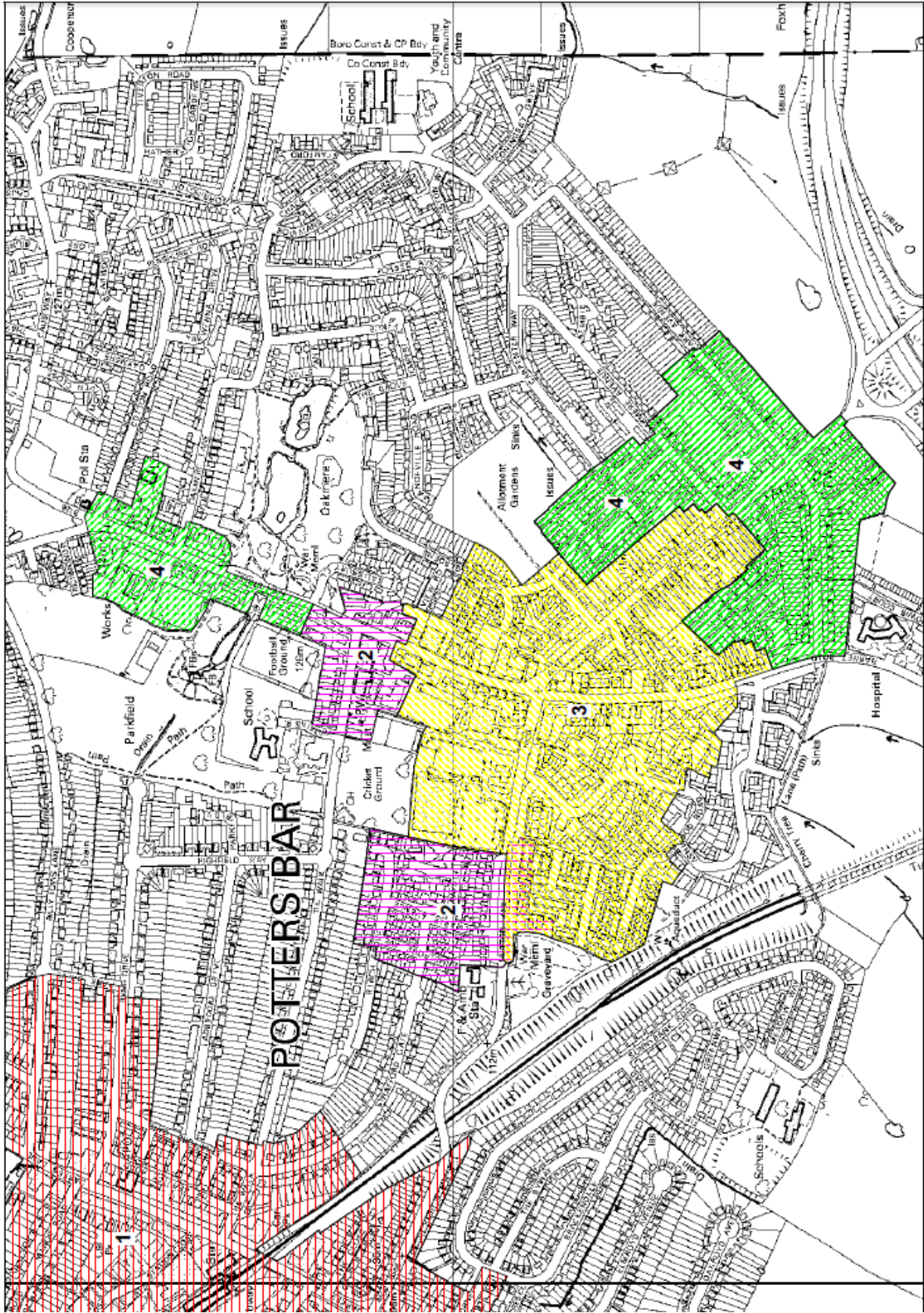

Map 8: Radlett

