

Supplementary
Planning Guidance:
*Warren Estate,
Bushey Heath*
Design Guide

September 2003



Hertsmere Borough Council

Supplementary Planning Guidance: **Warren Estate, Bushey Heath Design Guide**

1. Introduction

1.1 The Warren Estate was designated as part of The Lake, Bushey Heath Conservation Area on 23rd October 1998. The Warren Estate is defined on the attached plan and includes the following properties:

- 1-29 (odd) and 2-18 (even) Warren Road
- 1-31 and 33 The Comyns
- 1-7 (odd) The Lake
- 1-5 Coles Green
- 1-12 Rose Lawn

1.2 An Article 4(2) Direction was served on the above properties on the 13th March 2001 and later confirmed on the 26th July 2001. This had the effect of withdrawing a range of permitted development rights relating to household alterations. These include proposals relating to;



- The enlargement, improvement or other alteration of vertical tile hanging, a projecting bay, a garage or porch, front door or garage door, where any part of the enlargement, improvement or alteration would front a relevant location;
- The alteration of a roof slope, which fronts a relevant location;
- The erection or construction of a porch outside any external door and the external door in question fronts a relevant location;
- The erection of a building or enclosure which would front a relevant location, or where the part of the building or enclosure maintained, improved or altered would front a relevant location;

- The provision of a hard surface which would front a relevant location;
 - The erection, alteration or removal of a chimney on a dwelling-house or on a building within the curtilage of a dwelling-house; or
 - The erection, construction, improvement, or alteration of a gate, fence, or other means of enclosure within the curtilage of a dwelling-house and fronts a relevant location.
- 1.3 A second Article 4(2) Direction was served on the following properties only, on the 16th August 2001 and later confirmed on 15th November 2001.
- 1-29 (odd) and 2-18 (even) Warren Road
 - 1-31 and 33 The Comyns
 - 1-7 (odd) The Lake
 - 1-5 Coles Green
- 1.4 This withdrew permitted development rights relating to original 'Crittall' windows. This specifically relates to any property, which seeks:
- The enlargement, improvement or other alteration of any original 'Crittall' window, where any part of the enlargement, improvement or alteration would front a relevant location.
- 1.5 In confirming the two Article 4(2) Directions, the Bushey/Aldenham Sub-planning Committee resolved to produce Supplementary Planning Guidance (SPG) for the Warren Estate. It was also resolved that the public should be consulted prior to the finalisation of the SPG.
- 1.6 It should be noted that 'relevant location' is defined as 'development, which fronts onto a highway or an open space'.

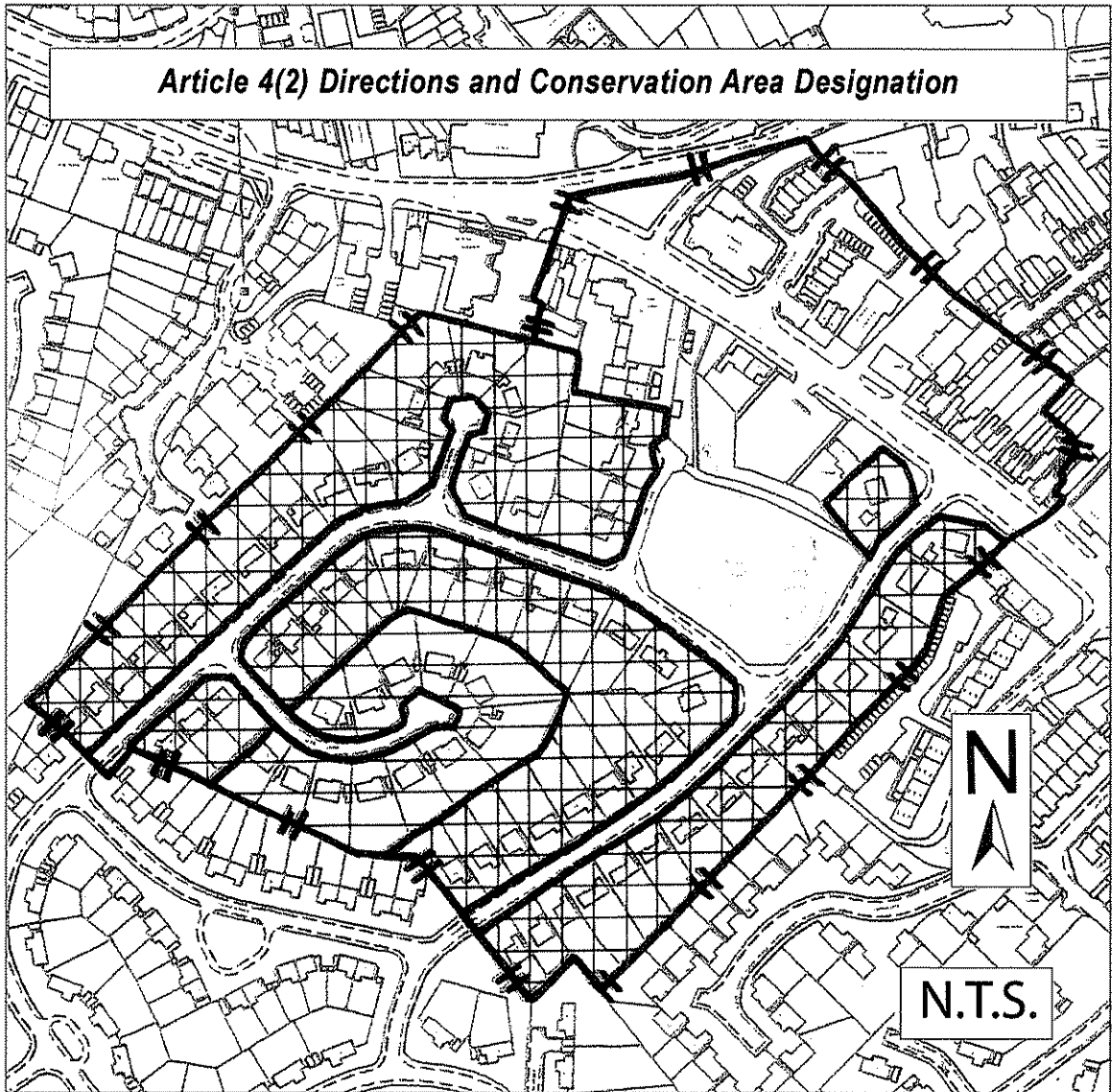
MAP OF WARREN ESTATE HIGHLIGHTING ARTICLE 4(2) COVERAGE



Based upon Ordnance Survey Mapping with the permission of the Controller of Her Majesty's Stationery Office Crown copyright.
Unauthorised reproduction infringes Crown copyright and may lead to prosecution or civil proceedings.
Licence No: LA078239 HERTSMERE. 2002.

Article 4(2) Directions	
	First Article 4(2) relating to household alterations as served on 13 th March 2001
	Second Article 4(2) relating to original 'Crittall' windows as served on 16 th March 2001
	Conservation Area Designation

2. The Role of Supplementary Planning Guidance (SPG)

- 2.1 Whilst only policies in a development plan have the status afforded by S54A of the 1990 Town and Country Planning Act, Supplementary Planning Guidance (SPG) may be taken into account as a material consideration. Planning Policy Guidance Note 12 'Development Plans' advises that the Secretary of State will give substantial weight to SPG in making decisions where that SPG emerges out of and is consistent with the development plan and has been prepared in a proper manner. Policy D20 of the Hertsmere Local Plan Adopted 2003 (HLP 2003) states that the Council will maintain a series of SPG leaflets to further develop and explain the application of policies in the plan. Policy D20 continues to state that SPG will be a material consideration in the determining planning applications and will be subject to public consultation.
- 2.2 Within the HLP 2003, the following Conservation Area policies are relevant;
- Policy E22: Conservation Areas - Preservation and Enhancement
 - Policy E23: Conservation Areas - Design of Development
 - Policy E24: Conservation Areas - Cumulative Effect of Small Scale Development
 - Policy E25: Conservation Areas - Detailing and Materials

3. Objectives of the Guidance

- 3.1 This SPG has been produced to provide clear advice for the determination of planning applications and covers the following matters:
- A summary of the historical development of Warren Estate;
 - The identification of the key characteristics, design and enhancement of the character of Warren Estate which should be reserved;
 - An outline of the key principles to good design and enhancement of the character of Warren Estate; and
 - The provision of full guidance with regards to the built form, openings, architectural features, material/finishes and landscaping.

4. Historical Development of the Warren Estate

- 4.1 After the Enclosure Act of 1809, the 'Rosedale Estate', which comprised of a large detached house set in substantial grounds, (later to become The Warren Estate in about 1870) passed through several hands. Two of the roads on the present estate were named after two of the previous owners, Charles Harling Comyns and Walter Selby Coles. From 1947 onwards the house remained empty and was eventually acquired by the developer Comben and Wakeling in about 1956/7. Comben and Wakeling had a reputation throughout the south east as quality house builders in the traditional style and they marketed the Warren Estate as a prestigious development of houses with character, built to pre-war standards. A total of 77 houses were built in the consistent design theme of the traditional 'English' country house style. The lake of the original estate remains as a highly significant landscape feature. In the early 1960's Comben and Wakeling also erected the 12 bungalows of Rose Lawn.
- 4.2 In November 1998 following strong support from local residents on the Warren Estate together with a number of properties along the High Road the area was designated as The Lake Conservation Area, on the grounds that it had sufficient special historical and architectural importance to merit protection.

HISTORIC MAP SHOWING ORIGINAL ROSEDALE AND SITE UNDER CONSTRUCTION (The existing residential estate is shown in outline)

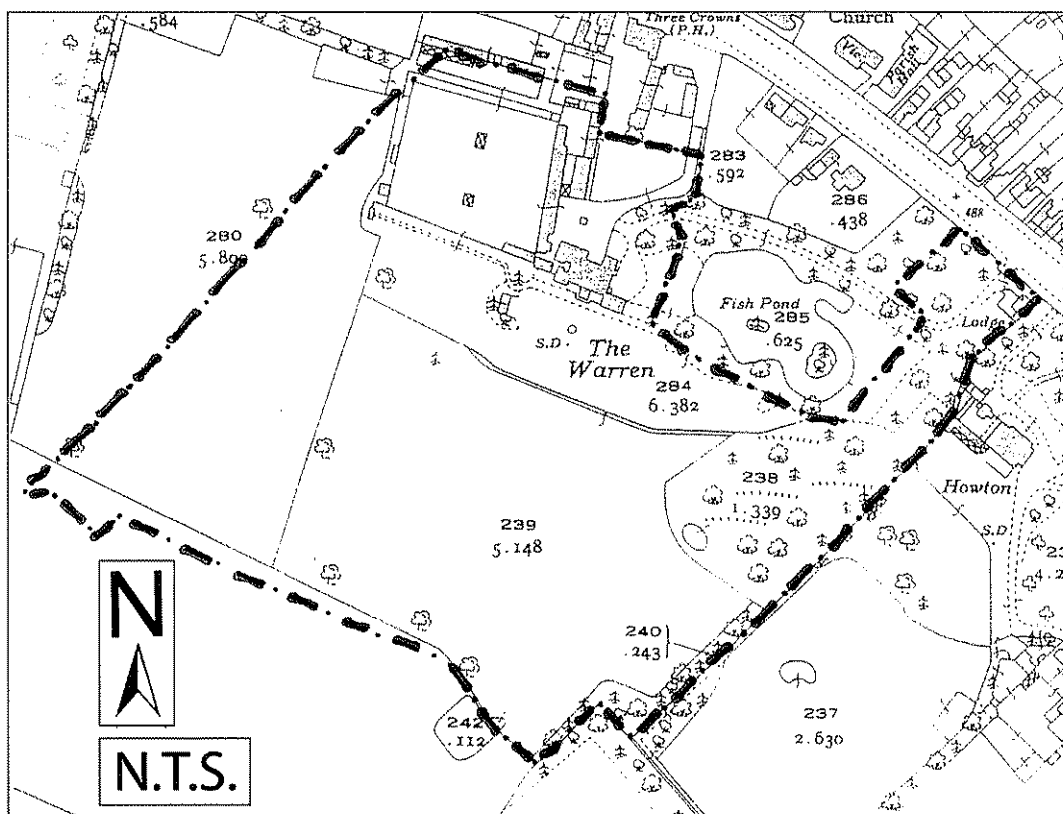

[3rd Ed. OS Extract] Source: Hertfordshire Archives & Local Studies

5. Character Assessment

5.1 The Warren Estate has a special character and appearance, which needs to be preserved or enhanced. This character can be broken down into three basic elements of urban layout, built form/architecture and materials. Each of these elements are described below. Together they define the character of the Warren Estate and highlight its importance as a unique planned residential development, designed and constructed to a high standard.

Urban Layout

5.2 The urban layout refers to the setting and pattern of the built form and the resulting townscape. The key characteristics are;

- Planned residential urban pattern.
- The Lake, a 'pocket-park' populated by a range of mature trees and a central pond, which acts as a focal point for local residents.
- 'U' shaped spinal road, which serves three cul-de-sacs.
- Low plot ratio, providing a loose urban grain.
- Large detached buildings with wide frontages, set in relatively extensive grounds.
- Buildings set back far from the road, providing a wide-open visually uncluttered aspect.
- Range of mature trees (some ornamental in species) predominantly sited within rear gardens, yet providing an important visual contribution to the character of the streetscape.
- Uneven landform with the high point at the junction with the High Road, which allows for long views to the countryside beyond (looking south west from the Estate).

Built Form/Architecture

5.3 The built form/architecture relates to the original form, scale, and style of the buildings. The key characteristics are;

- Large detached dwellings with predominantly wide frontages and narrow gable ends, resulting in a linear built form (except within Rose Lawn where the forms of the bungalows are less linear with wider gable ends in relation to the frontages).
- Solid steep roof pitches (approximately 45 degrees), with projecting eaves (except in Rose Lawn where the steepness of the roof pitches are approximately 40 degrees).
- Predominance of hipped roofs, with gable pitch projections, (in some cases with an outshut/cat slide).
- Two storey houses (except within Rose Lawn which are single storey).
- Partial tile cladding of upper floors, with 'kick-outs'.
- Integral or attached single garages, which sometime project beyond the main building line.
- Tall chimney stacks, which protrude beyond the profile of the roof.
- Distinctive flat topped open porches, supported by slender wooden posts, brackets or brick cheeks.
- Flushed 'Crittall' galvanised metal windows, with both horizontal and vertical slender glazing bars (except in Rose Lawn where the picture windows have minimum glazing bars).
- English bond brickwork and soldier brick flat arch over windows.
- Ground floor windows, predominately supported underneath by scalloped wooden brackets.
- Solid front wooden doors, with minimal glazing.
- Glass bricks in single or double columns on either side of the front door.

PHOTOGRAPHIC MONTAGE OF DIFFERENT HOUSE STYLES

GROSVENOR

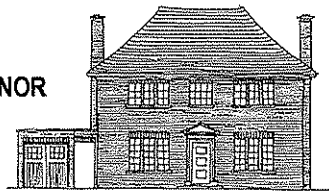

DORCHESTER



CLIFTON

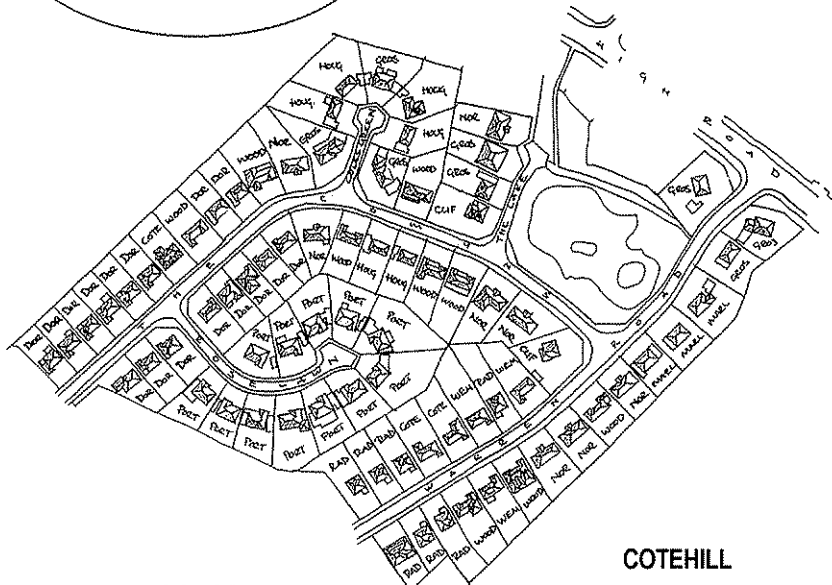

KEY	
CLIF	- Clifton
COTE	- Cotehill
DOR	- Dorchester
GROS	- Grosvenor
HOUG	- Houghton
MARL	- Marlborough
NOR	- Norwich
RAD	- Radel
WEM	- Wemyss
WOOD	- Woodcote

WOODCOTE



COTEHILL

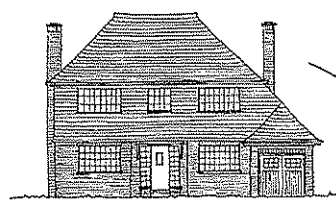

RADEL

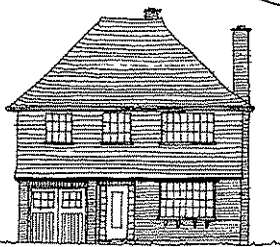

PORTLAND



There are 10 basic house and bungalow design types found on the Estate, which are listed on the key and of which some are illustrated. However within each design type there are variations which in some part reflect location (e.g. corner site) or in the case of a streetscene add interest through variations in the architectural form of the basic type.

Materials

5.4 Key materials used in the original construction of the houses are;

- Hand made, sand-faced multi-red stock bricks over clinker block inner walls
- Hand made, sand faced plain and bonnet hip red clay roofing tiles
- Plain clay hanging tiles
- 'Crittall' windows in galvanised metal and wood surrounds.
- Oak wooden front doors.
- Glass bricks for the surround of the main front door.
- Rendered or wooden cladded gable projections (in principally Rose Lawn)
- Single course of soldier on ends brick boundary wall.
- Gravel and 'colas' driveways.
- Cast iron railings (defining the boundary of The Lake)
- Iron and wooden slatted benches (within The Lake)

PHOTOGRAPHIC MONTAGE OF MATERIALS USED

The following photographic montage illustrates the diverse, yet coherent range of materials found on the Estate.

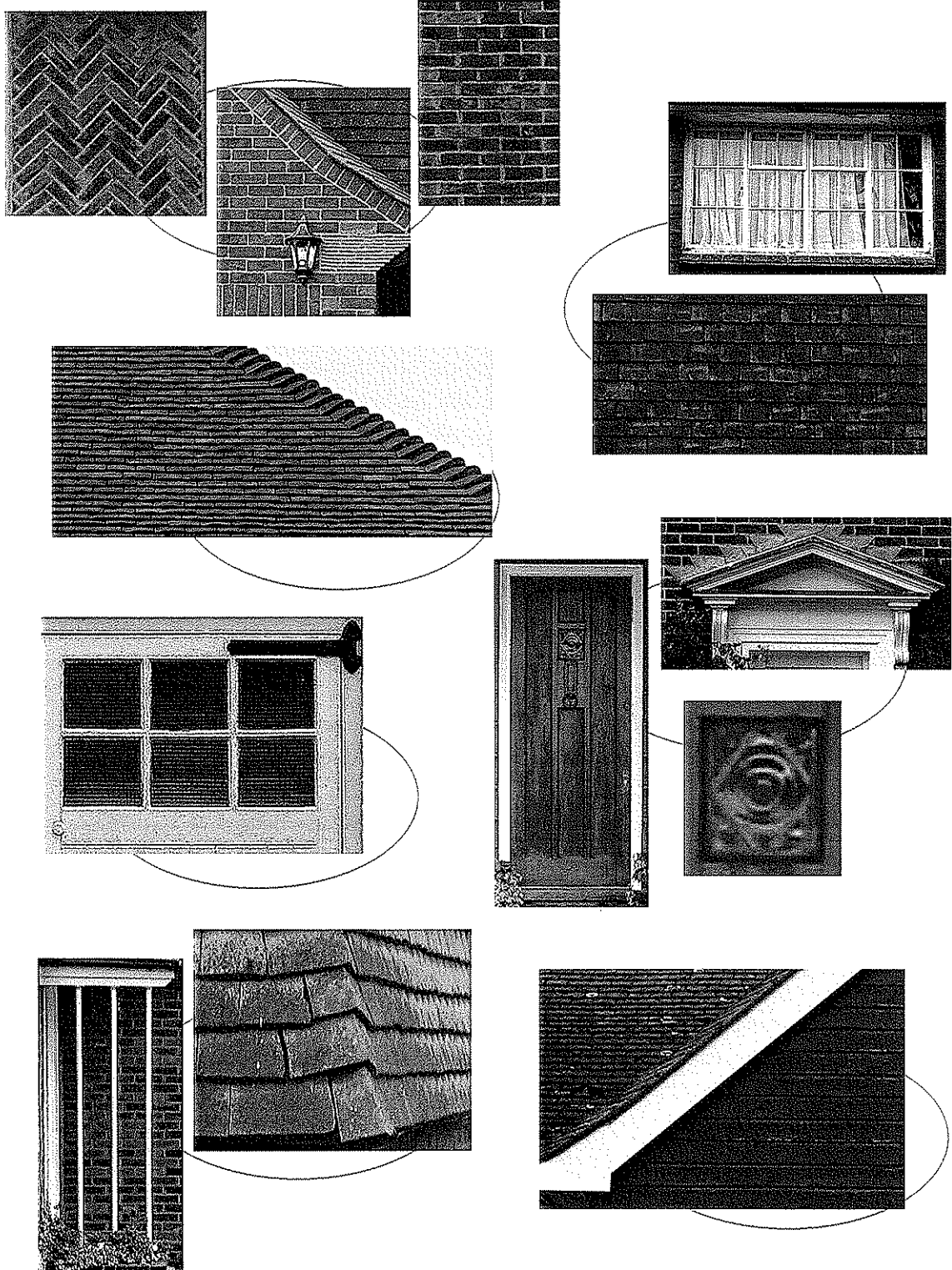

6. *Design Codes*

6.1 Warren Estate has a clearly defined character and appearance in terms of its layout, the built form, and its relationship with the external space, and architectural detailing. Any future alterations to these key elements that help define this character should be consistent with the original buildings and its setting in terms of form, scale, and style. Such works can have a significant visual impact upon the character and appearance of the building and upon the Conservation Area, therefore it is important to observe five key principles;

- **Form**
- **Scale**
- **Siting**
- **Design**
- **Sustainability**

6.2 Each of these principles will be explained within the following categories of the built form, openings, features, material/finishes, and landscaping. Additionally in each category, further detailed guidance will be provided on the design features considered necessary to achieve a successful proposal.

7. *Built Form*

7.1 The built form relates to the fundamental form and scale of the buildings within the Estate. In this case, the built form refers to the houses, bungalows, and associated outbuildings. The main pressure to alter the built form comes from the desire to extend existing dwellings in order to accommodate changes in lifestyles. Within this context, the following principles need to be adhered to;

Form - respecting the existing form and shape of the building by avoiding the introduction of dominant or alien forms

Scale - ensuring that the size of new extensions and alterations are subservient to the main body of the original building.

Siting - making sure that the balance of the original building is not compromised by siting inappropriate extensions and alterations and avoiding any proposals which would impinge upon the privacy or amenity of neighbouring properties.

Design - ensuring that the style of any extension or alteration complements the architecture and detailing of the original building.

Sustainability - supporting the repair and re-use of original features and materials and where replacement needs to take place, seeking materials from sustainable sources.

Extensions

7.2 Overall, extensions should be subservient in form and scale to the main body of the building and care should be taken in siting new extensions so that they do not have an adverse visual impact upon the character of the streetscape and the wider Conservation Area. Care should be taken to ensure that any proposed extensions also complies with Hertsmere's Guidelines for Domestic Extensions/Alterations (July 1991) - Supplementary Planning Guidance or as subsequently amended/replaced.

3D DIAGRAM & STREETScape DRAWINGS

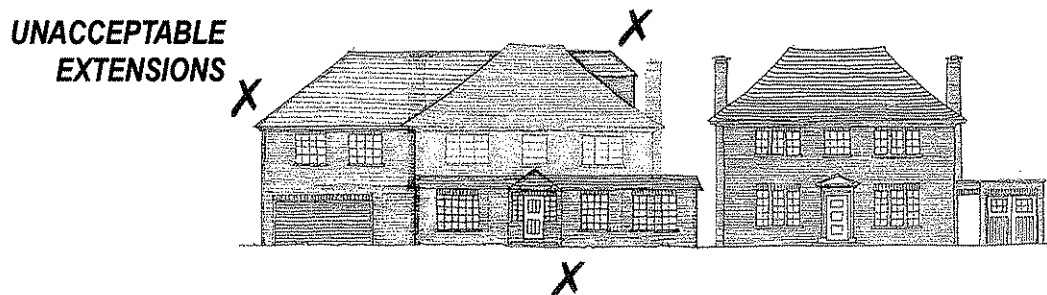
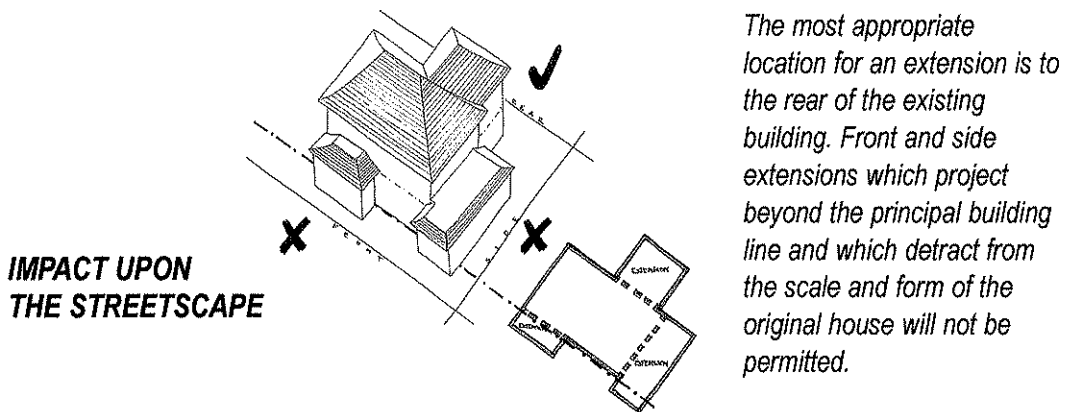

As demonstrated the existing profile of the examples shown are balanced, with subservient elements which do not detract from the character and appearance of the original house. Extensions which do not respect the original scale and form of the house will not be acceptable. The example shows how inappropriate changes can cause over dominance of the original form, distortion of the profile, and an imbalance in the architectural style of the building. All of these changes undermine the character and appearance of the house.

Front Extension (and extensions to corner buildings where an elevation faces onto a highway or open space)

- 7.3 Where an existing building has a single front elevation then the existing original building line of the main body of the dwelling should not be breached. In the case where an existing building has more than one elevation facing onto a highway or open space (e.g. corner plots), then extensions which breach the established building lines should be avoided.

Side Extension

- 7.4 Care should be taken to avoid the disfigurement of the existing profile of the building and to prevent the inappropriate loss of space, natural light and privacy between adjoining properties (i.e. 'sky gaps'). Any proposal which, when viewed from the public realm, does not complement the existing form and scale of the entire dwelling, including the roofscape will not be supported. Where side extensions are acceptable, they should not project forward beyond the building line of the main body of the dwelling.

PHOTO AND SKETCHES – SKY GAP

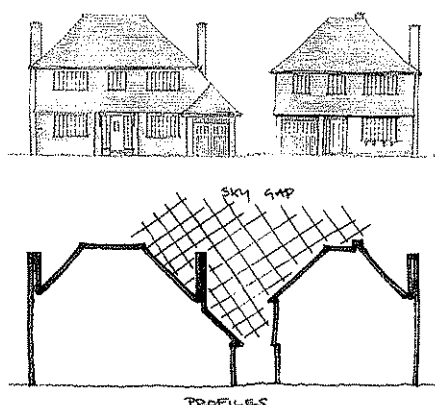
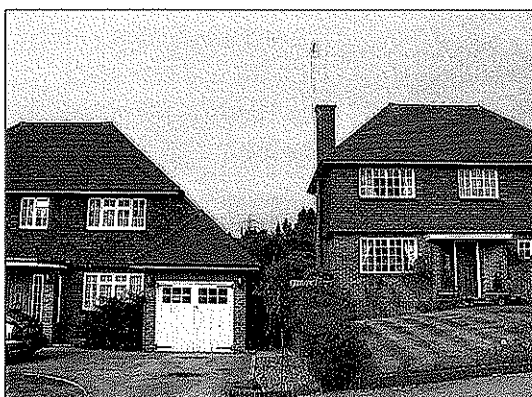

The photograph shows clearly how the combination of the underlying landform and the roof shape, profile and scale of the houses enables a 'sky gap' to exist, which provides visual relief in the streetscape. Inappropriate encroachment of this gap can undermine the character and appearance of the street and hence conservation area.

Rear Extension

- 7.5 This is considered to be the most suitable location for an extension to take place as long as it is not visually obtrusive, when viewed from the public realm, and does not compromise the basic form of the building. Any rear extension should be subservient to the main building. To achieve this any extension should be stepped away from the gable end of the original building, in order to form a break in the brickwork and roof plane.

SKETCH DRAWINGS OF GOOD AND BAD EXTENSIONS BY ANNOTATING THE ABOVE ADVICE NOTABLY THE PREFERENCE FOR REAR EXTENSIONS

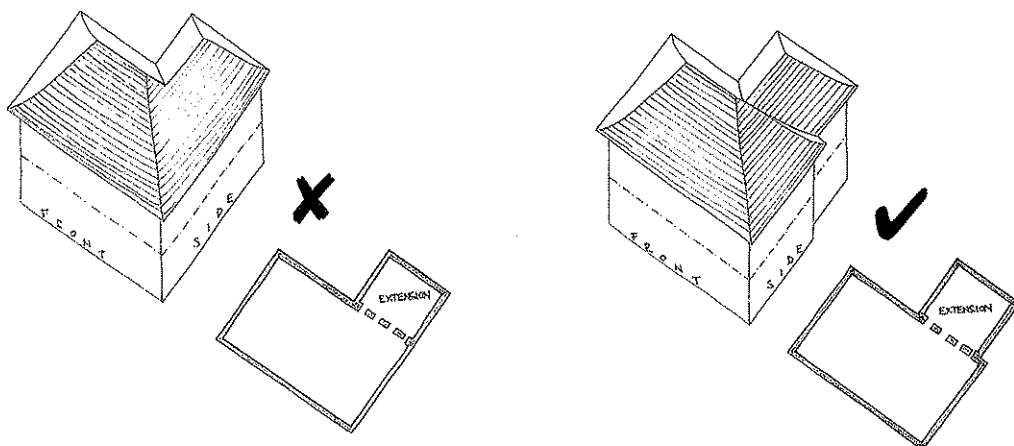

Without the introduction of a 'step' in the side gable and roof plane the proposed rear extension would distort and dominate the original form and scale of the house.

Garage Conversions into habitable space

- 7.6 Where there is a proposal to convert an existing attached garage into additional habitable space, then care needs to be taken to ensure that the architectural balance and design of the house is not compromised, and sufficient parking within the curtilage is provided. Where there is an existing original garage door then this, where possible, must be retained in situ. If a new garage is proposed which can accommodate the existing garage doors, then this may allow for its removal from its original position.

Roofs

- 7.7 The style and pitch of any new roof should reflect the predominant pattern of the existing building. This is principally hipped (ranging approximately between 40 to 45 degrees), but there are occasions when a gable pitch would be more suitable. Overall, the form, depth, and detailing of the eaves should be replicated.
- 7.8 The insertion of roof lights and solar panels will not be accepted on roofplanes, which can be seen from the public realm (i.e. highway and open space). Where the placing of a roof light is acceptable, then preference will be given to the use of 'conservation' style windows, whilst the scale of solar panels should not be disproportionate to the roof plane it is attached too.

UNACCEPTABLE ALTERATIONS TO THE ROOF

**PHOTO & SKETCH DRAWINGS
ANNOTATING THE ABOVE ADVICE
NOTABLY STEPPED ROOF AND
ROOFLIGHTS**

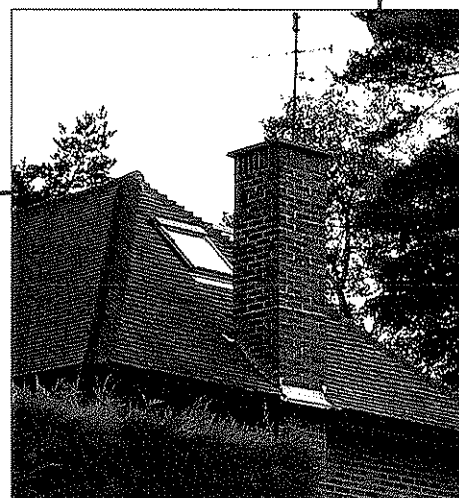
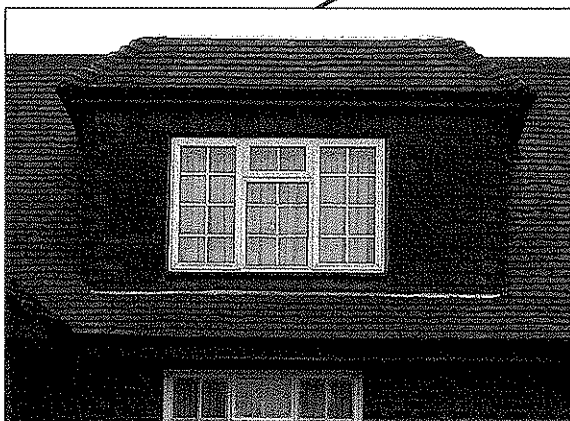
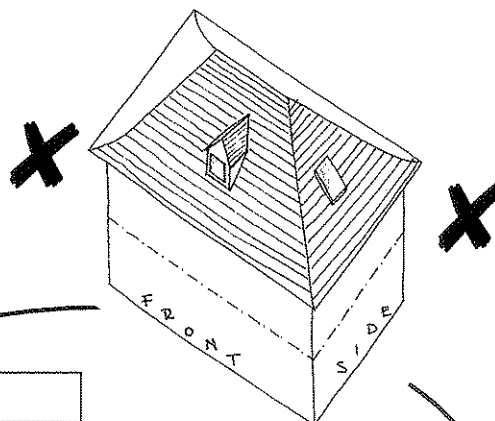

The photographs demonstrate how the introduction of rooflights or dormers on the roof plane, whether on the front or side plane can undermine the solidity of the roof, and detract from other key features.

8. Openings

- 8.1 Openings can be argued to represent the 'eyes' of a building in terms of windows and doors. The style and arrangement of the windows especially on the elevations of the buildings within the Estate are a key architectural feature, which merits special attention. Increasing pressure exists for the replacement of the original 'Crittall' windows with inappropriate imitations, on the grounds of energy conservation and low maintenance. This pressure is compromising a key architectural feature of the Estate and, therefore, undermining the preservation of the character and appearance of the Conservation Area. Within this context, the following principles need to be adhered to;

Form - respecting the existing form of the original "Crittall" windows and doors in terms of their shape, ordering, and arrangement of openings.

Scale - retaining the size and proportions of windows and doors, including its profile and internal subdivision in terms of function, and glazing bar arrangements.

Siting – avoiding the introduction of new openings, which would compromise the balance of the existing elevational arrangement of all openings and that would have an adverse impact upon the privacy of adjoining neighbours.

Design – ensuring that the styling, detailing, construction, and materials of replacement and new windows and doors are appropriate to the architectural integrity of the original design of the openings and the building as a whole.

Sustainability – ensuring the continued maintenance and restoration in situ of all original openings, especially the 'Crittall' windows, oak front doors, and side hinged top lighted garage doors. Avoiding the unnecessary replacement of all original openings without exploring the possible use of alternative or compensating methods of achieving improved energy efficiency and maintenance.

Windows

- 8.2 Originally, all the windows in the Warren Estate were Crittall metal frames, designed to fit standard openings. The design and dimensions of the window openings and the glazing patterns are important parts of the character of the houses and the Estate as a whole. Over the past years many of the original windows have been replaced with designs and which in some cases have caused harm the unique character of the Estate. The Council is therefore keen to ensure that replacement windows should not compromise the special character and appearance of the Conservation Area. It is appreciated that the general thrust of Government policy is to increase the energy efficiency of residential properties to reduce carbon dioxide emissions. Part L of the Building Regulations clearly supports this policy. This guidance however recognises the need to improve energy efficiency yet avoid compromising the special character

of historic buildings and areas. Therefore, in situations where replacement is proposed, the arguments for energy conservation against historic building conservation will need to be considered. With this in mind applicants will be encouraged to explore alternative or compensating methods of increasing energy efficiency (e.g. secondary glazing).

**PHOTOGRAPHIC MONTAGE OF GOOD ORIGINAL 'CRITTALL' WINDOWS
AND POOR IMITATIONS**

POOR IMITATIONS

Window designs considered not to be acceptable due to the arrangement, thickness and style of the glazing bars.

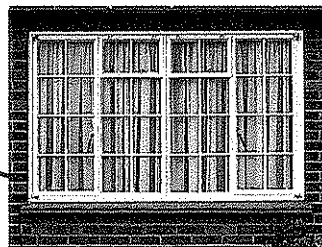
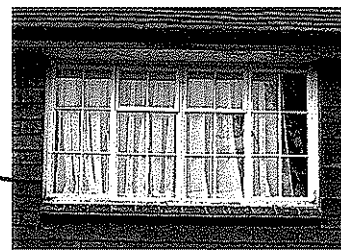
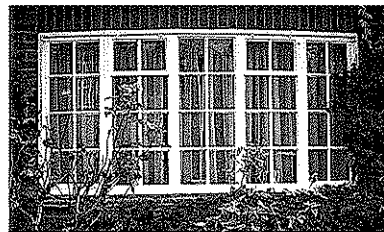
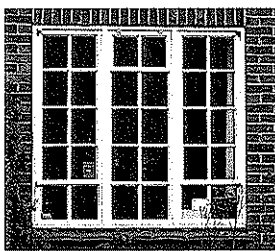
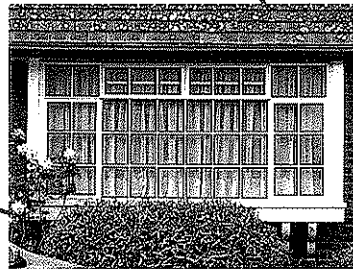
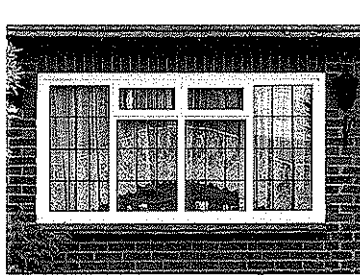

ORIGINAL WINDOWS

The photographs show how the original windows are well proportioned, in terms of the frame and glazing bars, which combined provide an slender, elegant window design.

- 8.3 Due to the mixture of windows which now exist within the Warren Estate it is considered necessary to provide guidance under the following scenarios;

Properties where original "Crittall" windows still exist (except Rose Lawn)

- 8.4 Encouragement will be given to the retention of the existing original windows and support given to their sympathetic repair. Where replacement windows are proposed they should come in the form of 'like-for like' white powder coated (i.e. galvanised steel or aluminium) which match the original in terms of openings, vertical emphasis of the casement lights, glazing bar arrangements and thickness, and material finish. Whilst the use of external glazing bars are considered more to reflect the original window design, the use of internal glazing bars in a 'Georgian' style will be accepted.
- 8.5 The use of UPV-c windows, will be resisted on the grounds that both the finish and the restrictive nature of the material would not sufficiently reflect the detailed design of the original "Crittall" windows and hence compromise the character of the Conservation Area.

Properties where replacement windows have been installed prior to the serving of the Article 4(2) Direction (except Rose Lawn)

- 8.6 The Article 4(2) Directions do not apply to windows, which front onto a highway or an open space, where the original 'Crittall' windows have already been replaced. In addition, the Directions do not apply to any other windows on other elevations within the Estate. However, encouragement will be given to the re-introduction of galvanised or powder coated metal (i.e. steel/aluminium) windows, which in terms of openings, vertical emphasis of the casement lights, glazing bar arrangements and thickness, and material finish, reflect the original "Crittall" windows. Whilst the use of external glazing bars are considered more to reflect the original window design, the use of internal glazing bars in a 'Georgian' style will be accepted. The use of UPV-c windows will be discouraged on the grounds that they would compromise the character and appearance of the Conservation Area.
- 8.7 In cases, where the replacement of windows has been piece-meal, (i.e. a mix of window types, age, and origin) then encouragement will be given to the re-introduction of white powder coated (i.e. galvanised steel/aluminium) framed windows. Replacements should in terms of their openings, vertical emphasis of the casement lights, glazing bar arrangements, thickness, and material finish, should reflect the original "Crittall" windows.

Properties within Rose Lawn

- 8.8 The current Article 4(2) Directions do not include control over the replacement of windows within Rose Lawn. However, encouragement will be given to the retention of the 'picture window' style, in terms of openings, glazing bar arrangements and thickness, and material finish.

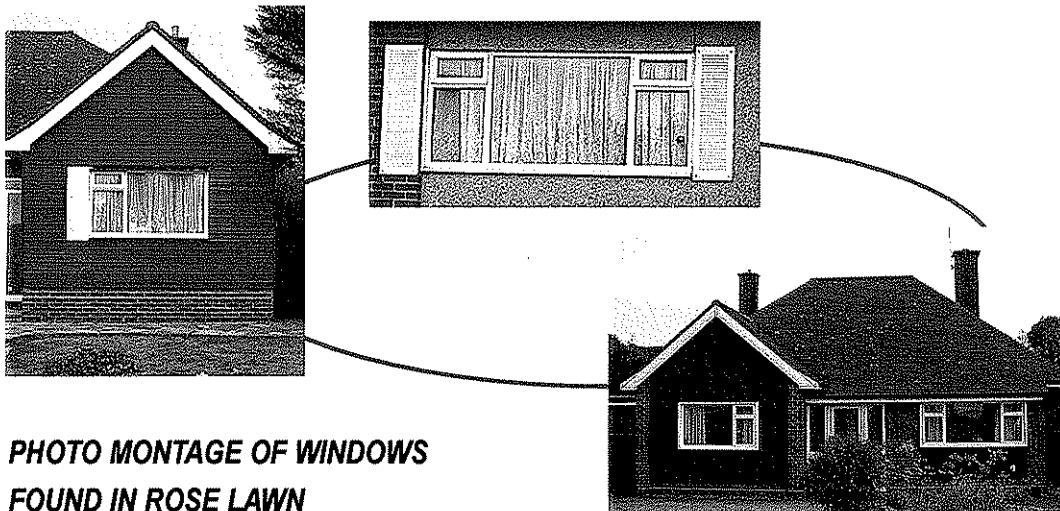
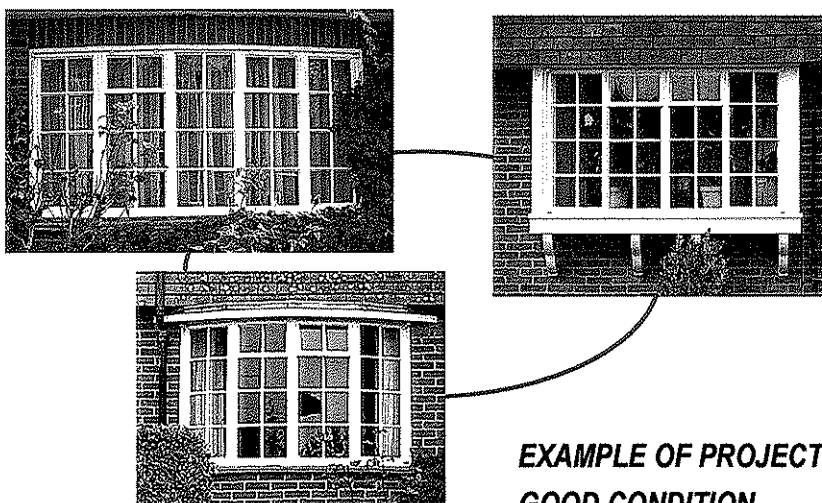

PHOTO MONTAGE OF WINDOWS FOUND IN ROSE LAWN

In contrast to the majority of the Estate, the windows in Rose Lawn are devoid of extensive glazing bars and are characterised as shown by large panes of glass.

Projecting Windows

- 8.9 All existing projecting windows on the ground floor should be retained in terms of form, method of support and materials. Their replacement with inappropriate designs and materials will be resisted.



EXAMPLE OF PROJECTING WINDOW IN GOOD CONDITION

As shown there are an range of different forms of projecting windows. Whether a bow or box window they are all key architectural features which are important to the character of the houses and the wider conservation area.

Doors fronting a relevant location

- 8.10 A variety of door designs and materials (e.g. UPV-c, aluminium etc..) exist which undermine the character and appearance of the Conservation Area. Preference will be given to the preservation of existing original doors. Existing original doors and associated glass bricks should be retained. Where replacement doors are proposed these should be sympathetic in design and materials to the original character of the buildings.

Principal Front Doors

- 8.11 All existing original Oak wooden doors should be retained. Where UPV-c doors exist and their replacement is being proposed a preference will be given to the reinstatement of doors, (except in Rose Lawn), that mirrors the style of the original wooden doors in terms of solidity and proportion of glazing. In Rose Lawn, UPV-c doors should be discouraged. The original doors used in Rose Lawn were predominantly highly glazed and less solid than those found on the rest of the Warren Estate, therefore encouragement will be given to doors of timber construction which are sympathetic to the glazing pattern of the original bungalow design.

Glass Bricks

- 8.12 All existing glass bricks, which act as side lights to the main front door, should be retained.

Garage Doors

- 8.13 All existing original garage doors should where possible be retained. Where replacement garage doors are proposed a preference will be given to timber constructed simple solid side hinged doors with inserted small upper horizontal glazing units, reflective of the original garage doors. Proposals including an 'up and over' mechanism will only be acceptable if they mirror the design of the original garage doors. Exception to this would be for garage doors within Rose Lawn, where solid doors were originally used.

GARAGE & FRONT DOORS

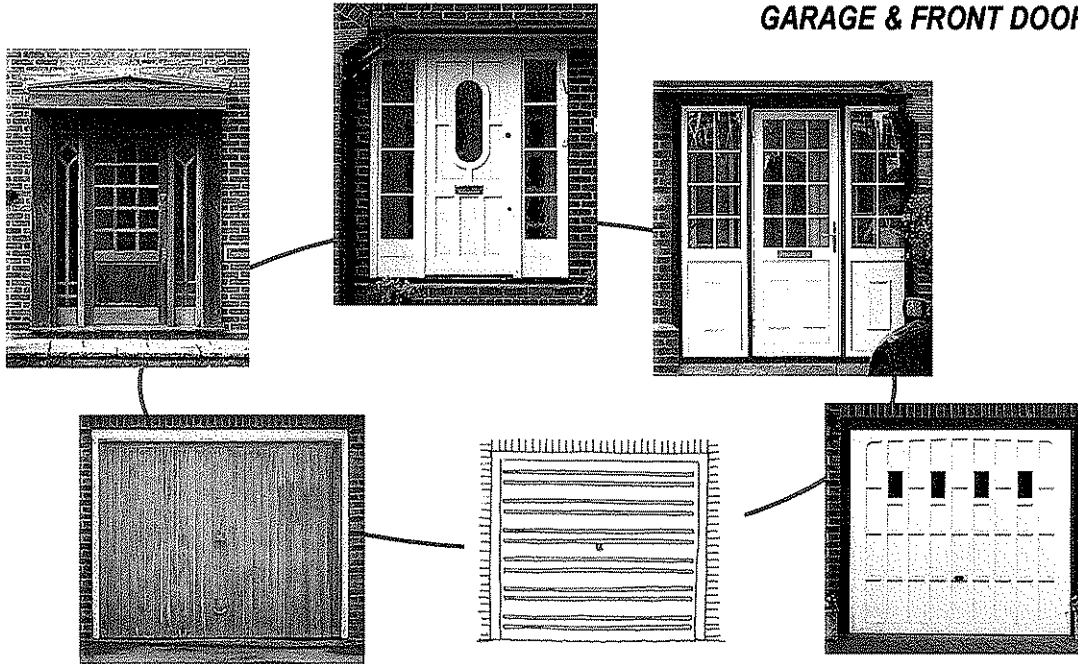

POOR EXAMPLES

Above is a sample of replacement front and garage doors which are considered to be unacceptable as they have resulted in the loss of original features and introduced designs which do not reflect the character and appearance of the existing houses.

None of these designs above reflect the original style of either the front or garage doors as shown below.

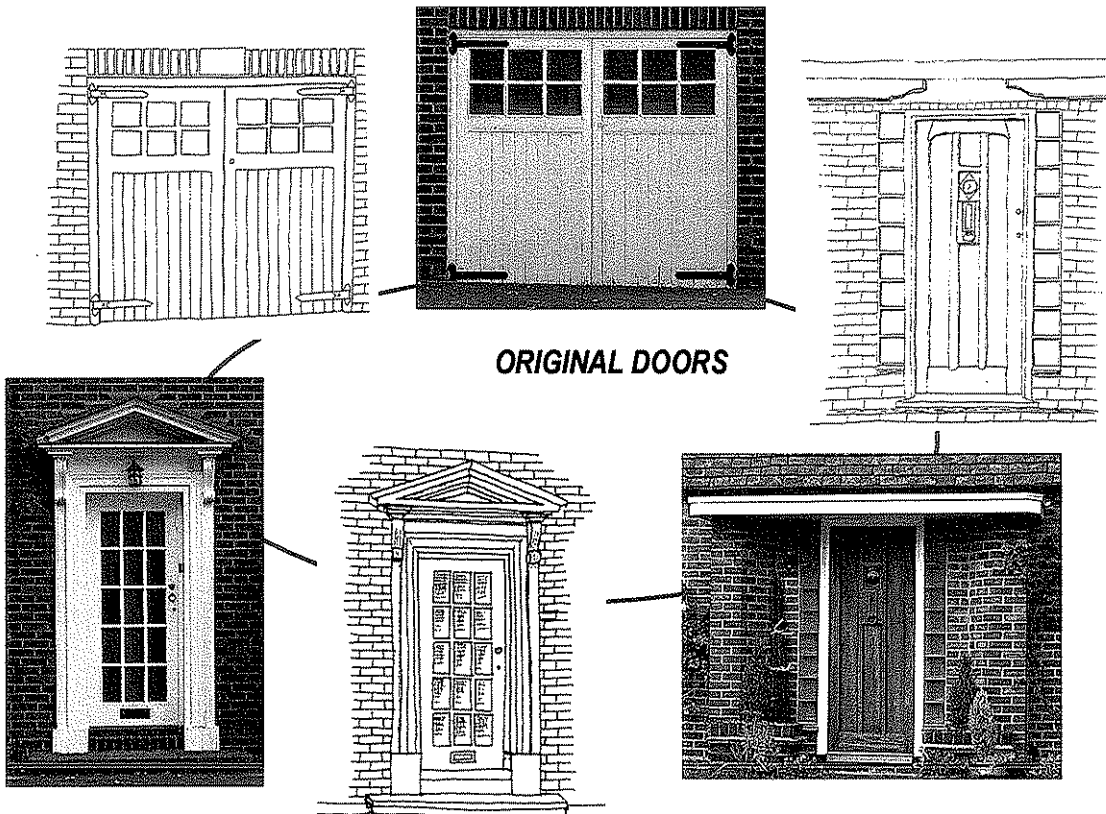

ORIGINAL DOORS

9. Features

- 9.1 Major contributors to the special character of the Warren Estate are the many individual features, which collectively reflect the architectural language of the buildings. These include the chimneys and porches. Inappropriate changes to these features can imbalance the rhythm of the original design and therefore compromise the character and appearance of the Conservation Area. Within this context, the following principles need to be adhered to;

Form - protecting the form and shape of existing key architectural features.

Scale - ensuring that the proportions and size of any original key feature are not compromised.

Siting - avoiding the introduction of new features, that would compromise the balance of the existing arrangement of the form, shape, or elevation treatment of the building.

Design - ensuring that any new features complement the architecture detailing of the original building.

Sustainability - supporting the repair and re-use of original features and materials and where replacement needs to take place, seeking materials from appropriate sustainable sources.

Chimneys

- 9.2 All chimneys should be retained, in terms of scale, form and detailing. In the case where the repair is not sufficient to maintain the original structure then, a replacement must be provided which replicates the original design.

Porches

- 9.3 The original design incorporated a variety of canopies in terms of design. Those remaining which are still in their original form should be retained in terms of openness, scale, design and material finish. Proposals to enclose existing open canopies will be resisted, as enclosed porches were not an original design feature of the buildings.

PHOTO MONTAGE OF KEY FEATURES (CHIMNEYS, CANOPIES AND GLASS BRICKS)

These key features add interest and variety to the individual buildings and the streetscape. Cohesion still exists between the features due to the use of the sympathetic design and materials. The list below helps to define the key features which influence the character and appearance of the buildings and the conservation area.

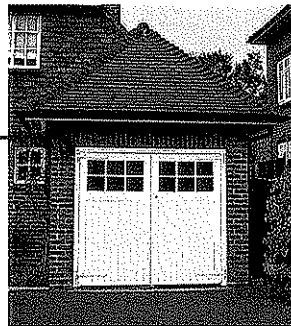
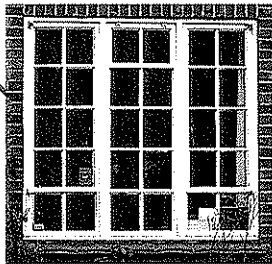
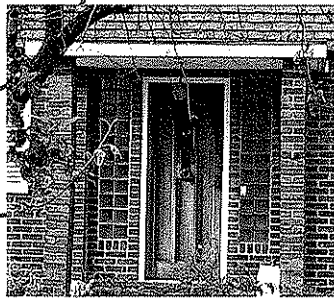
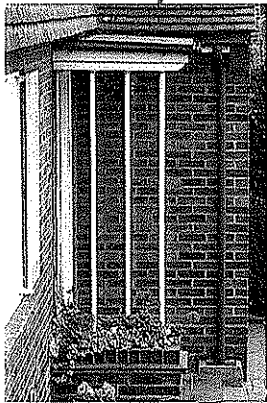
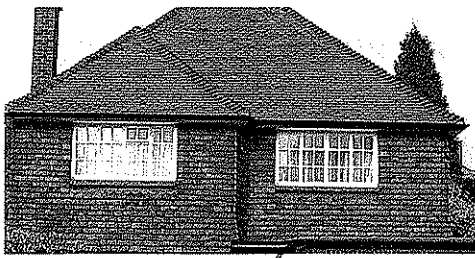

- Chimneys
- Garage doors
- Front doors
- Windows
- Porches

- Roof shape
- Sky gap

10. Materials/Finishes

10.1 The external material finishes and detailing represent the 'fabric' of the buildings and their inappropriate use can have an adverse impact upon the character and appearance of the Conservation Area. Within this context, the following principles need to be adhered to;

Form - ensuring that the form and shape of the external finishes and detailing respect the original building.

Scale - ensuring that the proportions and size of any original detailing are not compromised.

Siting - avoiding the introduction of new materials and detailing, that would compromise the balance of the existing texture and colour, or elevation treatment of the building.

Design - ensuring that any new external materials and detailing compliments the existing finishes, in terms of colour, texture, and style of the original building.

Sustainability - supporting the repair and re-use of original details and materials and where replacement needs to take place, seeking materials from appropriate sustainable sources.

Materials and Colour

10.2 A preference will be given to the use of materials which complement the texture, finish, and architectural detail of the existing dwellings. Therefore, in terms of the built form care should be taken in the use of materials, where necessary handmade which match those originally used in the construction of the dwellings. These include;

- sand-faced multi-red stock bricks
- sand faced plain and bonnet hip red clay roofing tiles
- plain clay hanging tiles
- rendered or wooden clad gable projections (in principally Rose Lawn)

10.3 Where new materials are proposed, where possible, these should not be introduced on the public frontage of the building. For example, in terms of re-roofing, original tiles should be used on the roof planes visible from the public highway or open space whilst the new tiles should be placed on the rear plane.

Details

- 10.4 Care should be given in the use of external materials via the use of appropriate detailing. In terms of the brick bonding, brick sizes, hanging tile arrangement, and roof features, these should match those features and details found on the original dwellings.

PHOTO MONTAGE OF MATERIALS/COLOURS AND DETAILING IN ORDER TO ILLUSTRATE A MATERIALS PALETTE

The fine details and use of sympathetic materials as shown help reinforce the quality of the Estate and its cohesion in its appearance. These details must be retained and replicated in the case of any new build.

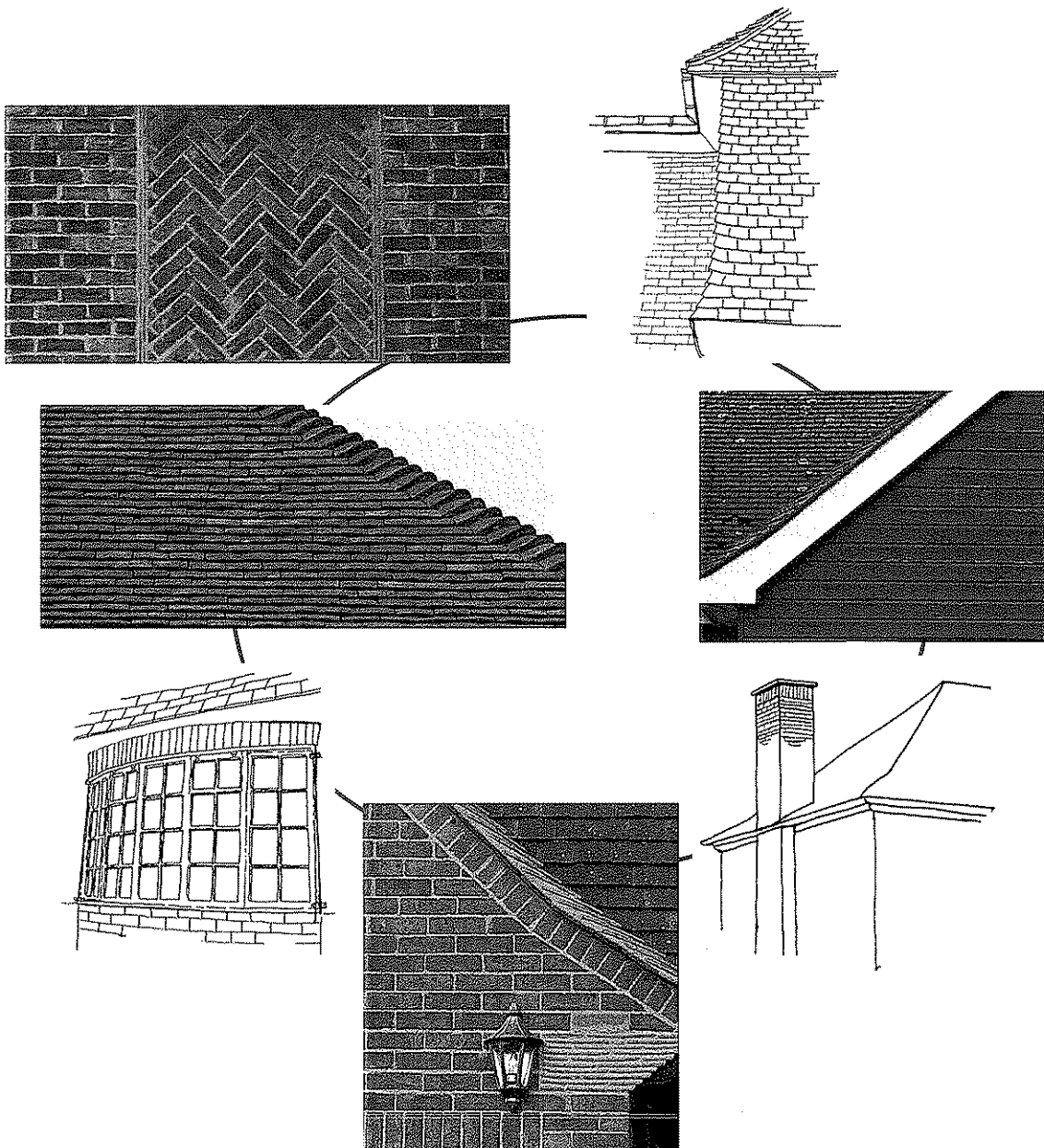

11. Landscaping

11.1 The appropriate treatment of external spaces with materials and designs, which are complimentary to the existing buildings, can enhance the overall environment of a Conservation Area and help preserve its special character. Overtime there has been a series of works, principally related to hard landscaping which are visually obtrusive and which have incrementally and detrimentally altered the character of the Conservation Area. This has come in the form of excessive areas of hard surfacing, inappropriate designs, unsuitable colours, and textures, the loss of trees and other vegetation, and potentially the desire for increased enclosure. Within this context, the following principles need to be adhered to;

Form - avoiding the introduction of alien or dominant forms and shapes of landscaping that would compromise the setting of the buildings.

Scale - ensuring that the scale of any new permanent landscaping feature respects the openness of the streetscape and do not compromise the setting of the buildings.

Siting - avoiding the inappropriate placement of permanent landscape features, which would distort and visually obscure the openness of the streetscape and compromise the setting of the buildings.

Design - encouraging the design of visually unobtrusive landscape style combined with the use of natural materials, which would complement the architecture of the original building.

Sustainability - ensuring the repair of existing, original features and materials and where new construction needs to take place encouraging the use of materials from sustainable sources.

Fences and walls

11.2 All original low brick walls, which define the front boundary of the properties, should be retained. This includes the retention of existing brick planting boxes that are found at the end of boundary walls adjacent to the entrance points of each property. Preference will be given to the re-instatement of brick walls, which reflect the original design of which the vast majority is single soldier or two soldiers and two-stretcher combination. Regardless of the design any permanent boundary treatment (i.e. fence and/or wall) of a height greater than 250mm (approx. 9 inches) above ground level on any garden that fronts onto the public realm should be avoided.

PHOTO MONTAGE OF BOUNDARY TREATMENT

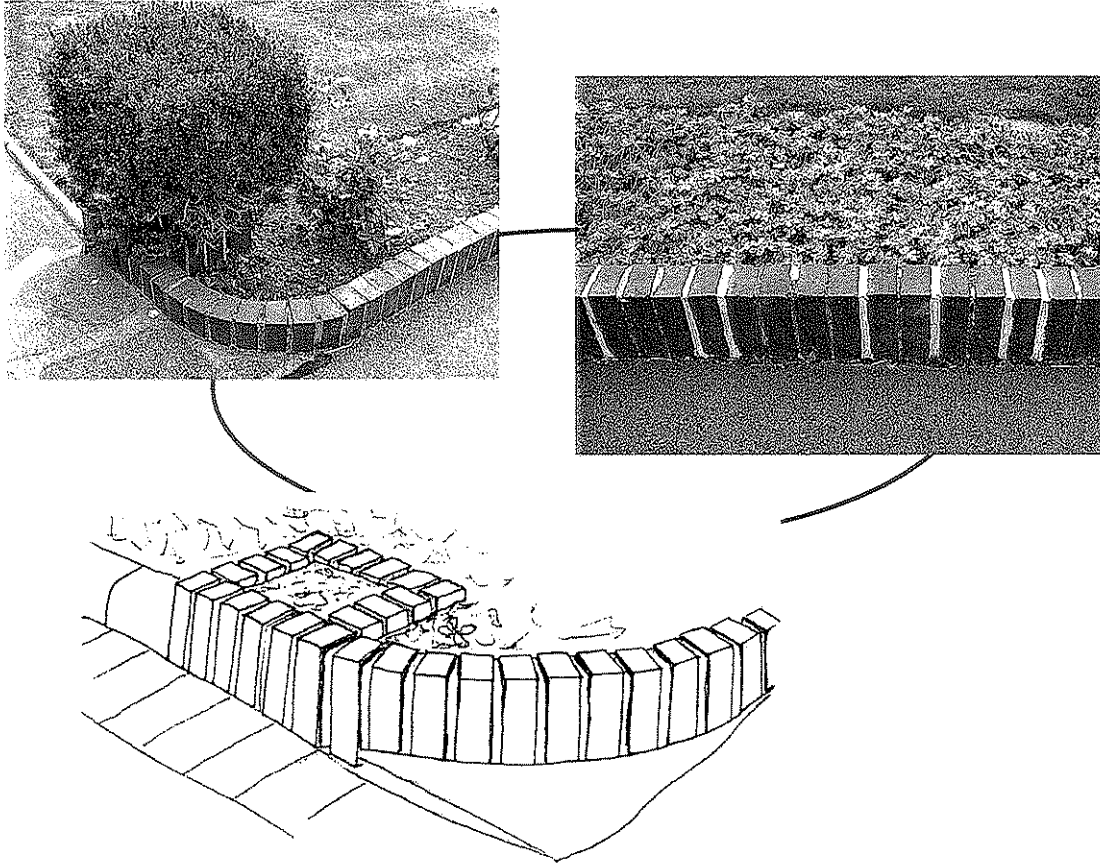

As with the detailing, the boundary treatment found in the Estate, help to reinforce the quality of the Estate and its cohesive appearance. These details must be retained and replicated in the case of any new build or alterations.

Hardsurfacing

- 11.3 A number of properties already have extensive hard surfacing in place. Extensive hardsurfacing of front garden areas is considered to be detrimental to the character of the Conservation Area. Further proposals for similar hardsurfacing will be resisted. If hardsurfacing is proposed then this should not dominate the front garden of the associated house or the character of the streetscape. Where replacement hardsurfacing is proposed additional soft landscaping will be encouraged.
- 11.4 Where a property was originally designed with one access point then the creation of a second access point may be acceptable if the additional hardsurfacing created does not cause an imbalance in the relationship between the existing soft landscaping and hard surfaces. If the total hardsurfacing as a result of the new access point dominates the visual appearance of the front garden then the proposal to form a second access point will be resisted. In cases where a second access is proposed then details of how the existing low brick boundary wall and/or planter features, then details of how these will be sensitively altered, must be submitted.

Materials for Hardsurfacing

- 11.5 A preference will be given to the use of materials, which in terms of texture and colour are neutral and have a visually unobtrusive impact upon the setting of the dwellings and the character of the Conservation Area. Acceptable materials include, gravel (which can be bonded), setts, cobbles and tarmac (without contrasting coloured chips). Care should be taken to ensure that the colour selection for any of these materials should harmonise but not match with the colour of the original building.
- 11.6 However, designs such as fantail, ring circle, spania, uni-decor or basket weave style, 'wet-look' surface treatment, 'crazy-paving', contrasting colours and/or contrasting textures in the hardsurfacing are considered to be incompatible with the principle of neutral and visually unobtrusive hard surfaces. Block pavers is also considered to be generally inappropriate given in that it can convey a municipal and engineered appearance unacceptable within the Estate. Simple patterns of a generally uniformed colour will be more acceptable.

**ILLUSTRATION OF SUGGESTED BALANCE BETWEEN EXCESSIVE
HARD SURFACING AND RETENTION OF THE SOFT LANDSCAPING**

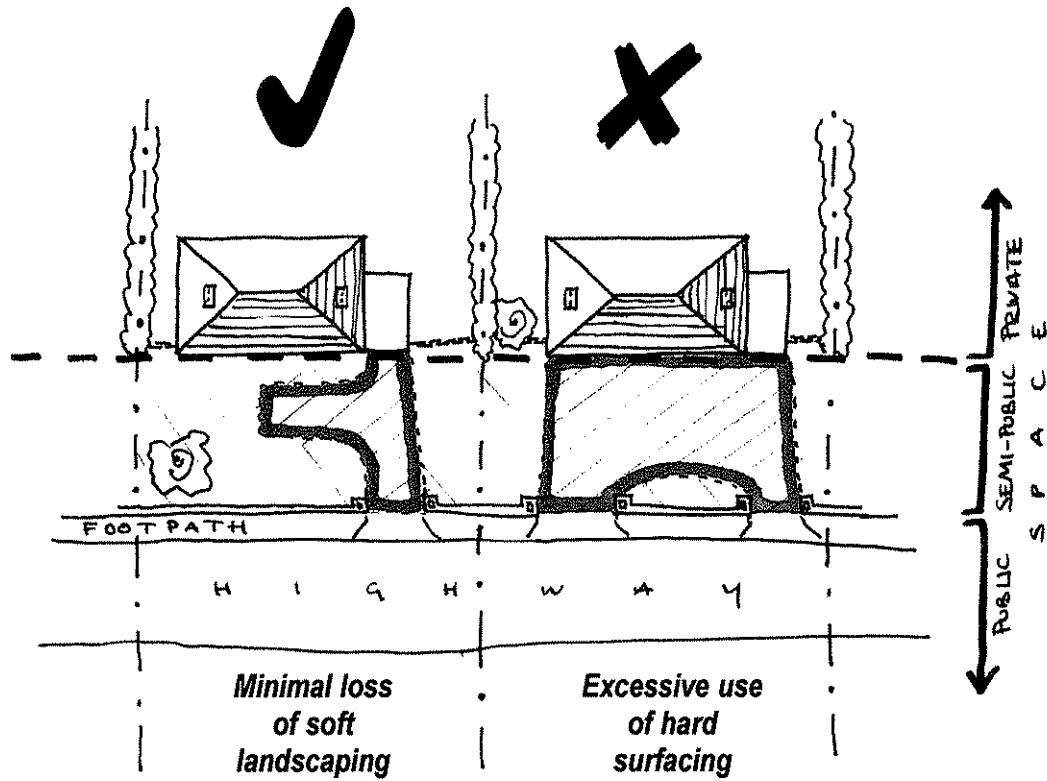

The example on the right demonstrates how care needs to be taken in providing a second access point, as the resulting additional hardstanding can dominate the front garden area. This is not acceptable.



GOOD EXAMPLE

ILLUSTRATE RANGE OF GOOD AND BAD MATERIALS IN TERMS OF COLOUR, PATTERN AND TEXTURE

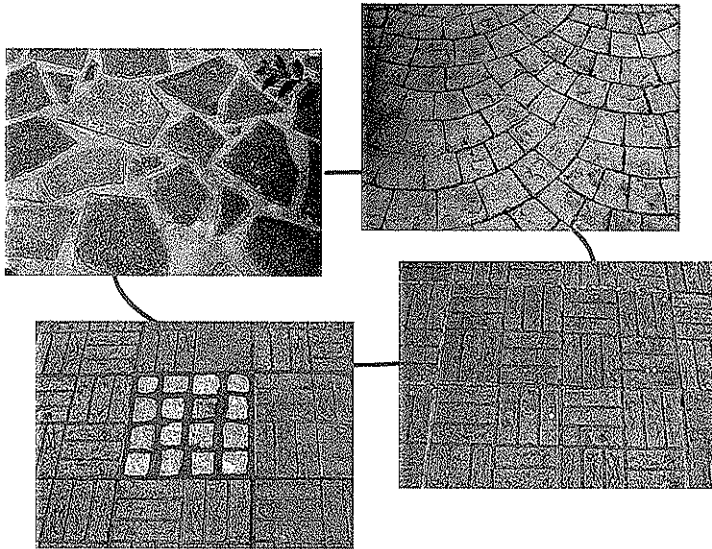

POOR EXAMPLES

The poor examples demonstrate how the inappropriate use of colour, texture and pattern can create a hardsurfacing that would detract both from the setting of the building and the appearance of the streetscape.

KEY ISSUES TO CONSIDER

- Colour, eg. neutral
- Texture, eg. matt not gloss
- Pattern, eg. avoidance of dominant patterns

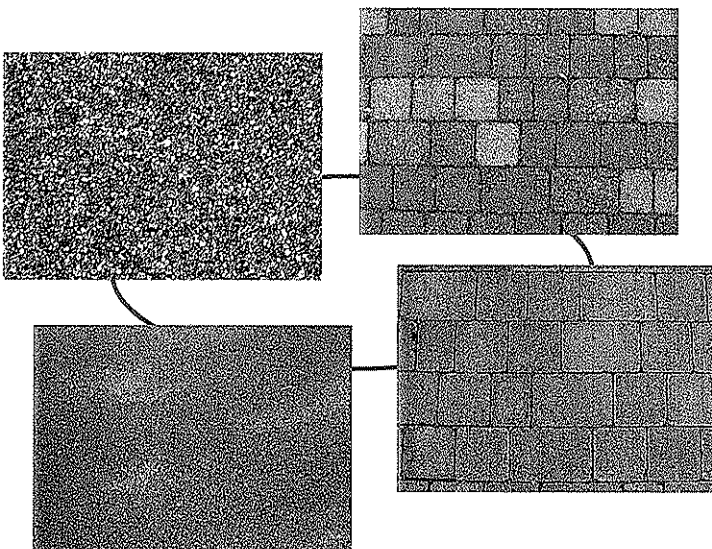

GOOD EXAMPLES

The good examples shown is not an exhaustive list, but demonstrate that surfaces that are neutral in colour, have uniformity in texture and is visually flat, and not reliant upon an over dominant pattern are considered to be acceptable

Soft landscaping

- 11.7 Retention of areas which front onto the public realm and which are characterised by extensive soft landscaping will be encouraged.
- 11.8 For further information on the maintenance and replacement of trees then contact the Councils Tree Officer. Details are provided at the rear of the guidance. In addition guidance can be obtained from the Department of Transport and Local Government Regions publication 'Protected Tree - A Guide to Tree Preservation Procedures' and from the Arboricultural Association 'Trees for Small Gardens'. The following provides a list of species of trees considered to be acceptable if there is a desire to plant a new or replace an existing tree;

Acer davidii	snake barked maple
Acer campestre	field maple
Acer compestre elsrijk	ornamental field maple
Acer griseum	paperbark maple
Acer negundu	box elder
Aesculus flora	yellow buckeye
Betula nigra	river birch
Betula papyrifera	paper bark birch
Arbutus unedo	strawberry tree
Carpinus betulus	ornamental species
Cercidiphyllum	katsura
Crategus prunifolia	cockspur thorn
Davidia involvcrata	handkerchief tree
Fagus sylvatica dawyck	fastigate beach
Fagus sylvatica aurea	fastigate beach
Laburnum	golden rain
Magnolia	
Malus	ornamental fruit (apple)
Prunus	cherries
Sorbus	rowans

Further Information

If you require any further advice and guidance then please contact:

Conservation:

Graham Saunders - (Conservation and Urban Design Officer)

Tel: 020 8207 7528

Email: graham.saunders@hertsmere.gov.uk

Trees:

Graeme Golding - (Tree Officer)

Tel: 020 8207 7501

Email: graeme.golding@hertsmere.gov.uk

Building Control:

Michael McGinty - (Divisional Building Control Officer)

Tel: 020 8207 2277 (extn 5930)

Email: michael.mcginity@hertsmere.gov.uk

General Address:

Hertsmere Borough Council,
Civic Offices,
Elstree Way,
Borehamwood,
Herts WD6 1WA

Note: On the 25th September 2003, the Council's Bushey/Aldenham Planning sub-committee resolved to adopt this guidance with immediate effect. The Council's Statement of Consultation and the Schedule of Responses to the Public Consultation can be obtained from the Planning, Transport & Building Control, Hertsmere Borough Council, Civic Offices, Elstree Way, Borehamwood, Hertfordshire WD6 1WA. Telephone no. 020 8207 2277.

